

RIFUGIO LE SALIERE

PROGETTO ESECUTIVO IL RISTORANTE IL BAR



BY LOCI SAS DELL'ING. ANDREA LORENZINI

LOCI s.a.s.
Dell'ing. ANDREA LORENZINI & C.
Via 1° Maggio, 34 - 62100 MACERATA
P.IVA 01606980439



BANCALINA
OKITE EMPERADOR

RIVESTIMENTO
TAVOLE
ABETE

LOCI s.d.s.
Dell'ing. ANDREA LORENZINI & C.
Via 1° Maggio, 34 - 62100 MACERATA
P.IVA 01406980439

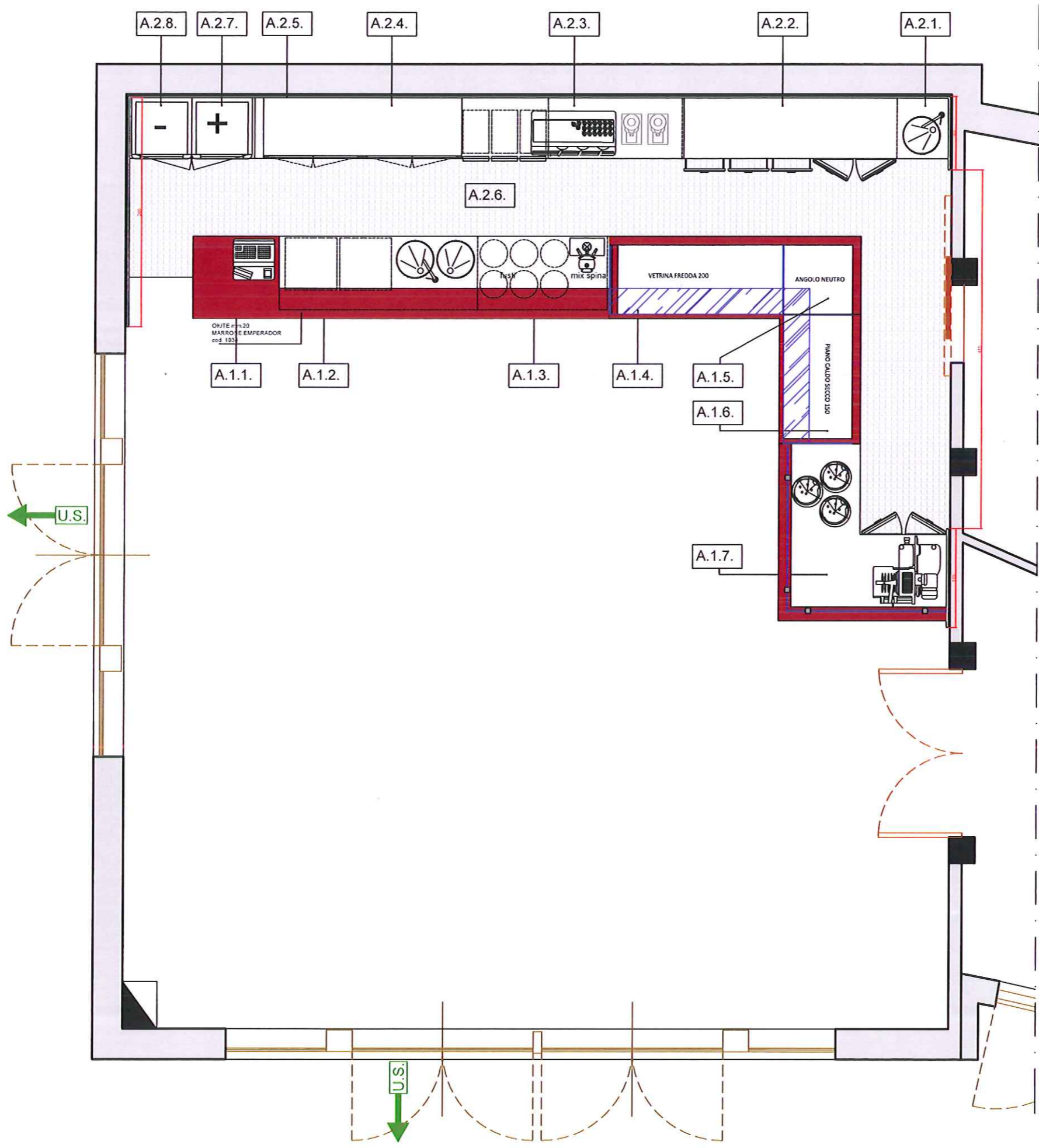

LOCI s.a.s.
 Dell'ing. ANDREA LORENZINI & C.
 Via 1° Maggio, 38 - 62100 MACERATA
 P. IVA 016980439

TAV. 02-01 BAR PLANIMETRIA TOTALE

02/09/2015 scala 1:50

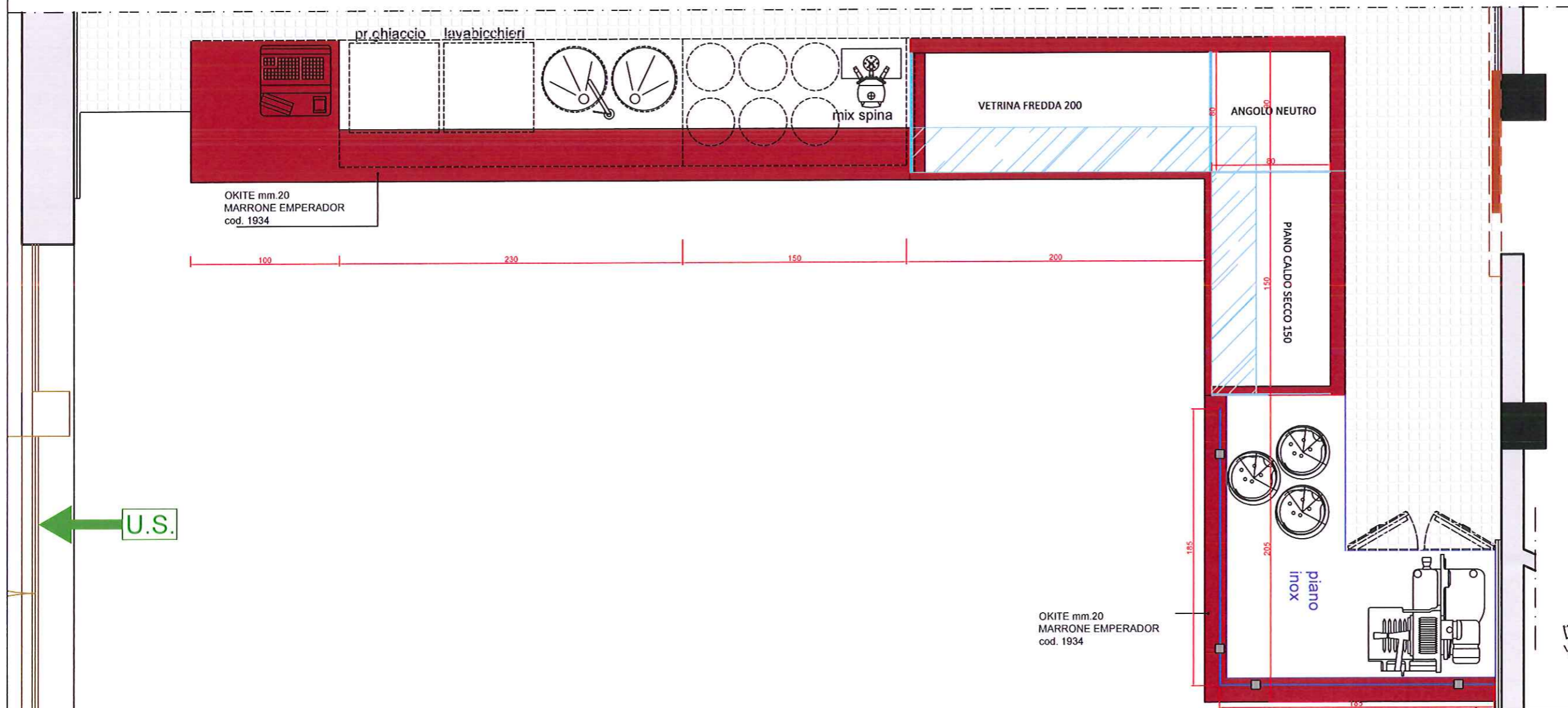
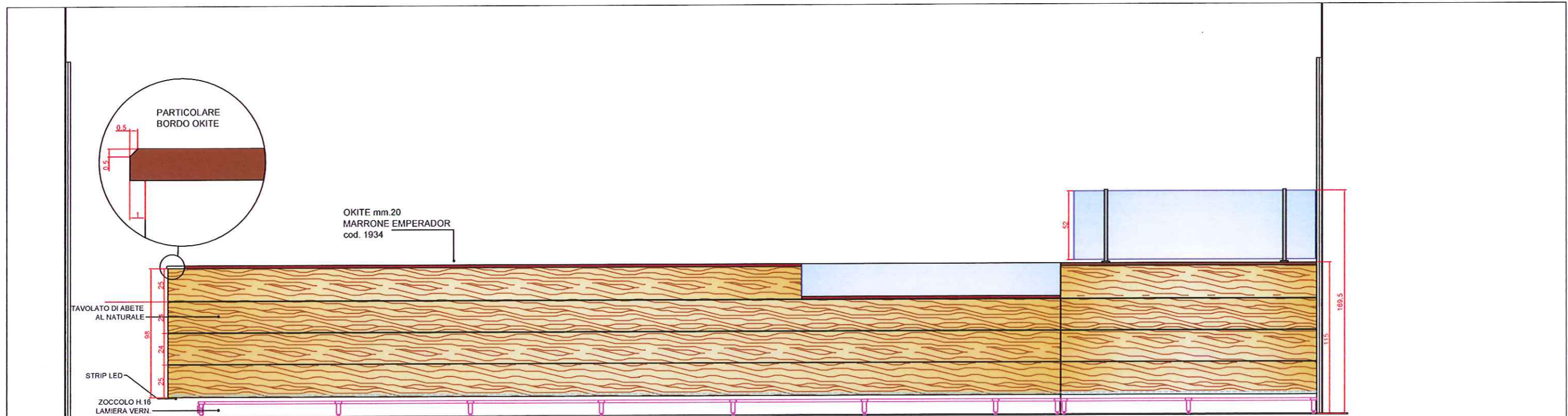

LOCI s.a.s.
 Dell'ing. ANDREA LORENZINI & C.
 Via P. Maggiora 3H - 62100 MACERATA
 Tel. 0733 606980439

TAV. 02-02 PROSPETTO BANCO BAR

02/09/2015 scala 1:30

TRAVE COPERTURA LAMELLARE

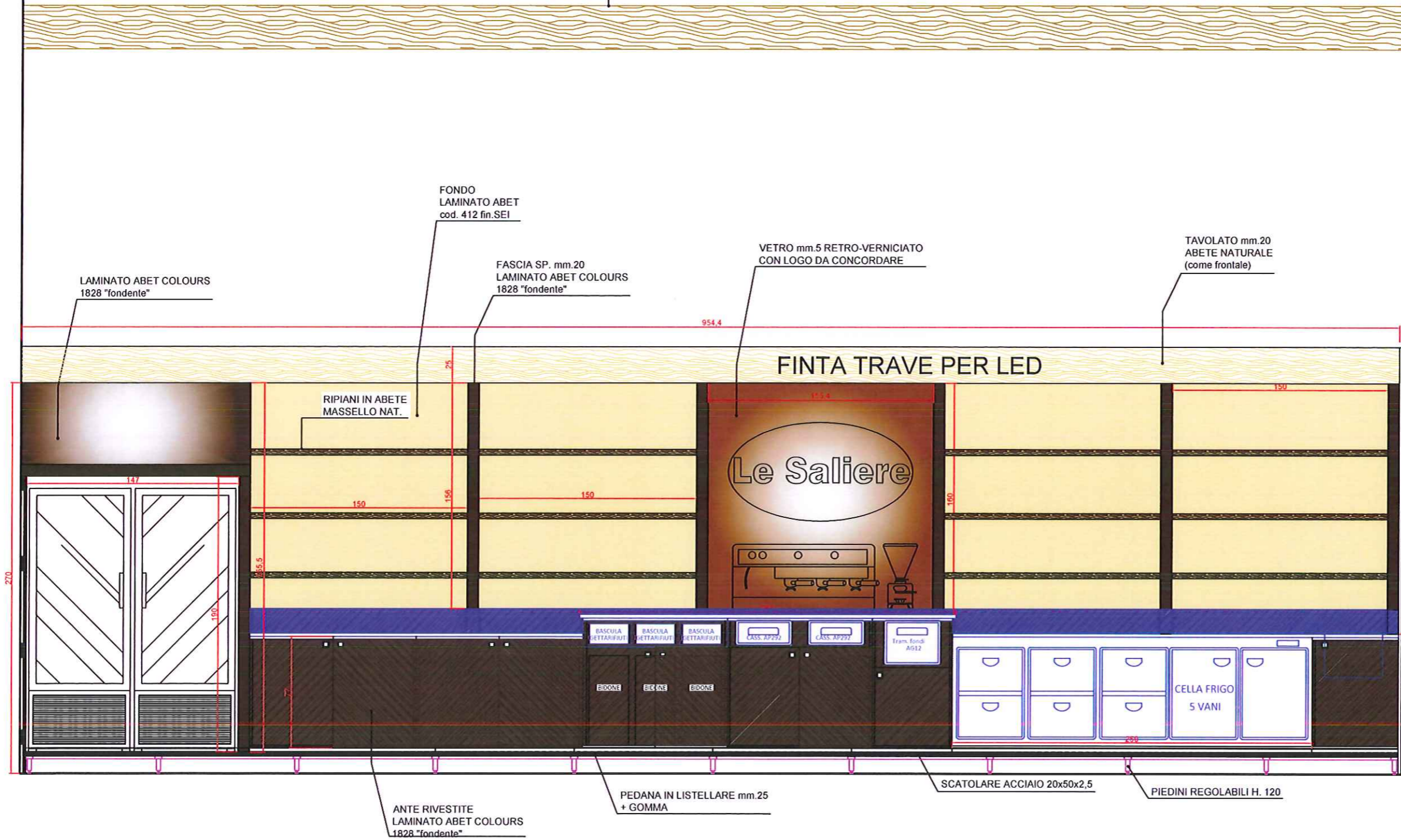

LOCI s.a.s.
 Dell'ing. ANDREA LORENZINI & C.
 Via C. Magli, 3H - 62100 MACERATA
 P. IVA 01606980439

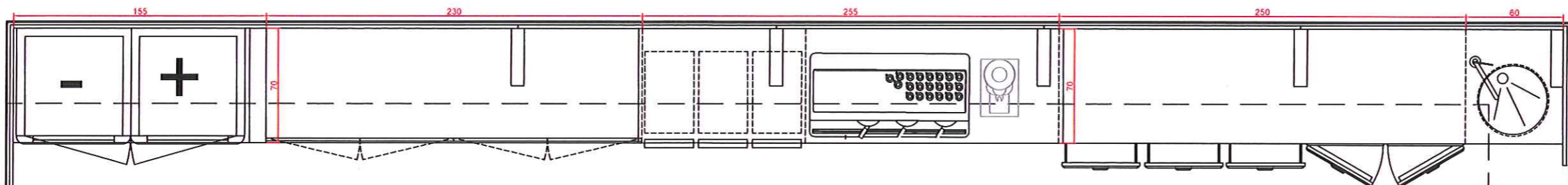

TRAVE COPERTURA LAMELLARE

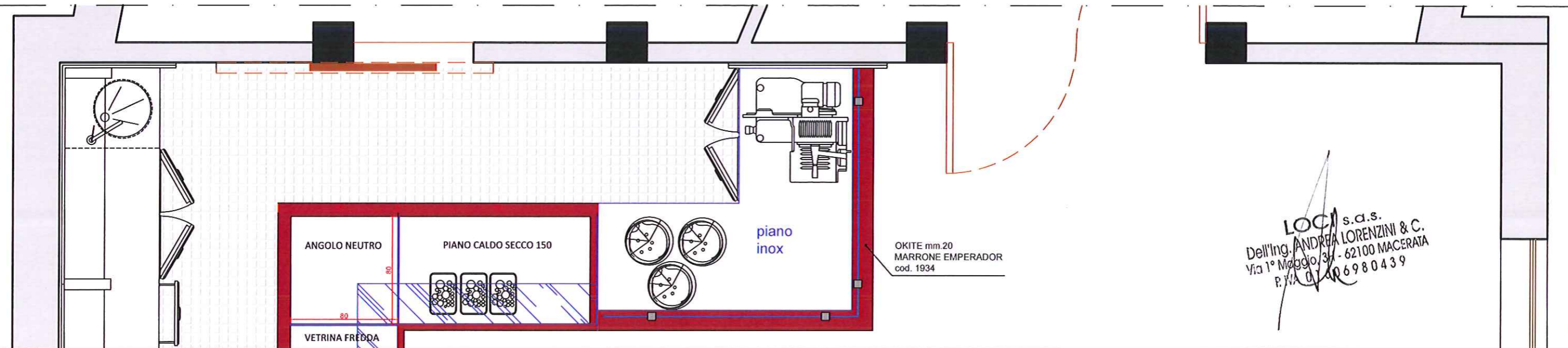
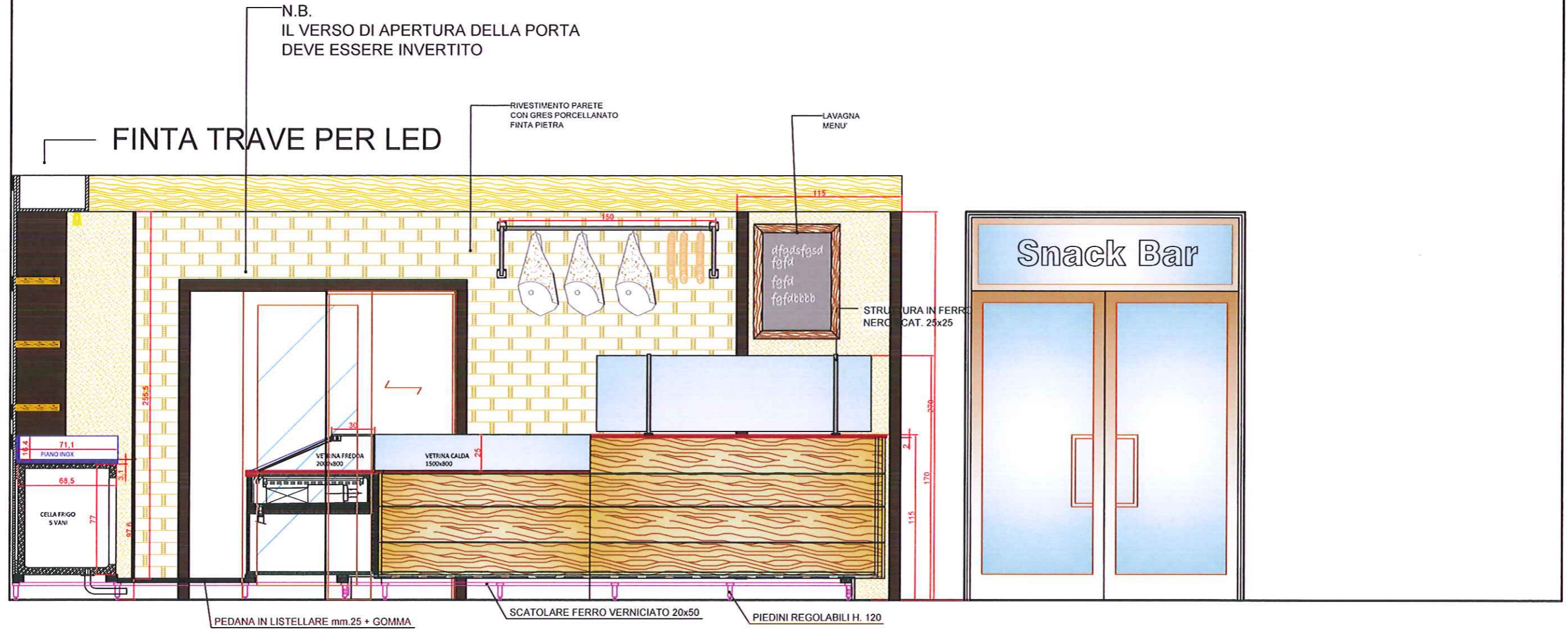

LOCI s.a.s.
Dell'ing. ANDREA LORENZINI & C.
Via 1° Maggio, 34 - 62100 MACERATA
P. IVA 01406980439

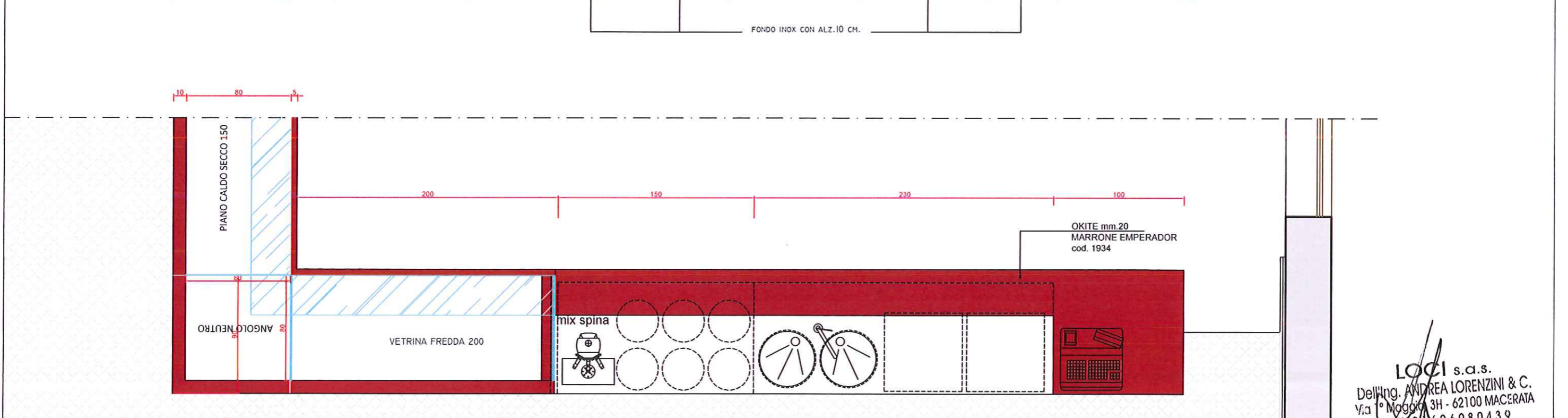
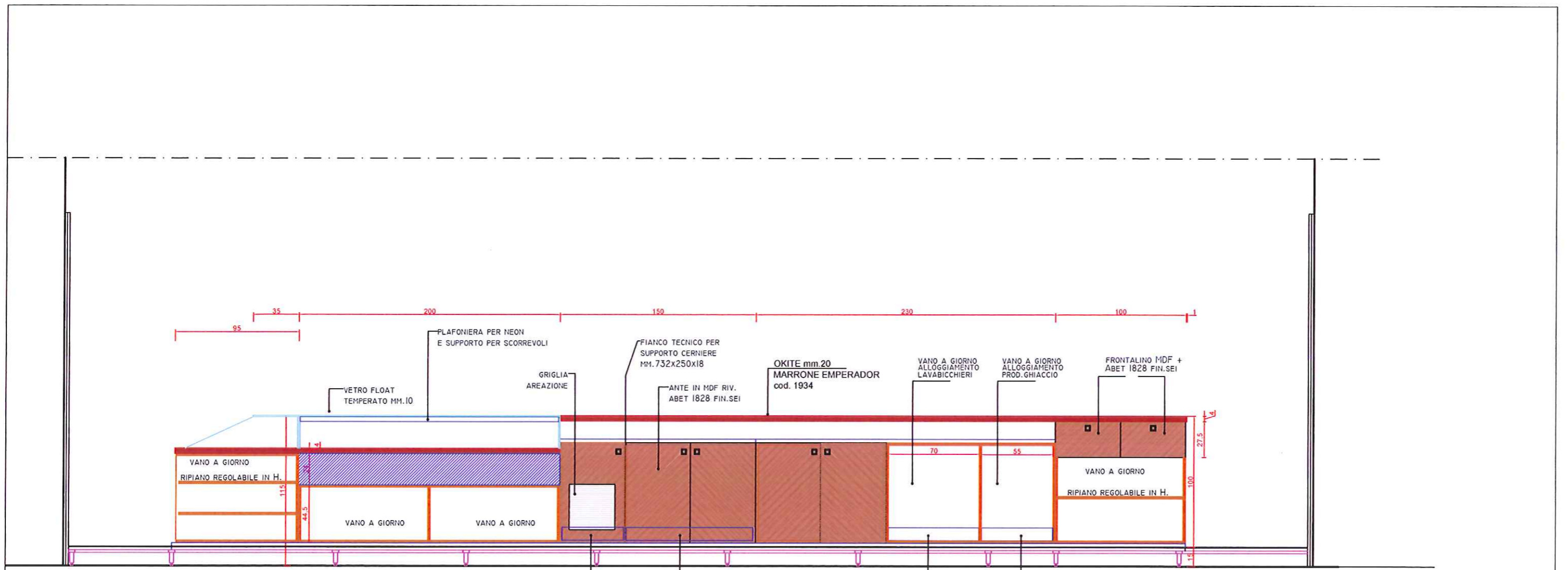

LOCI s.d.s.
 Dell'ing. ANDREA LORENZINI & C.
 Via Moggi 3H - 62100 MACERATA
 P. 0734/0606980439

TAV. 02-05 PROSPETTO BANCO BAR - LATO OPERATORE scala 1:30

07/09/2015

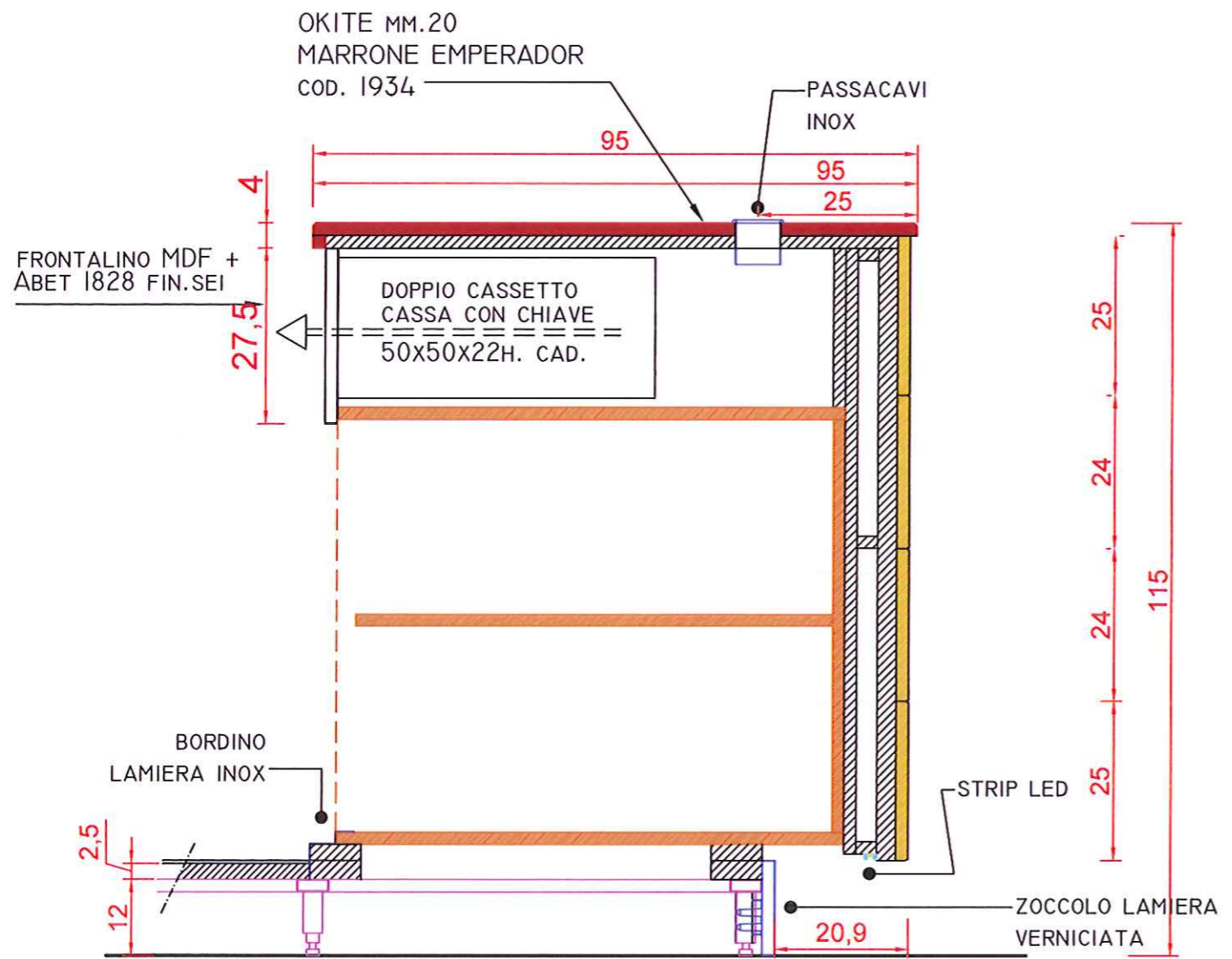

SEZIONE AA': BANCO CASSA

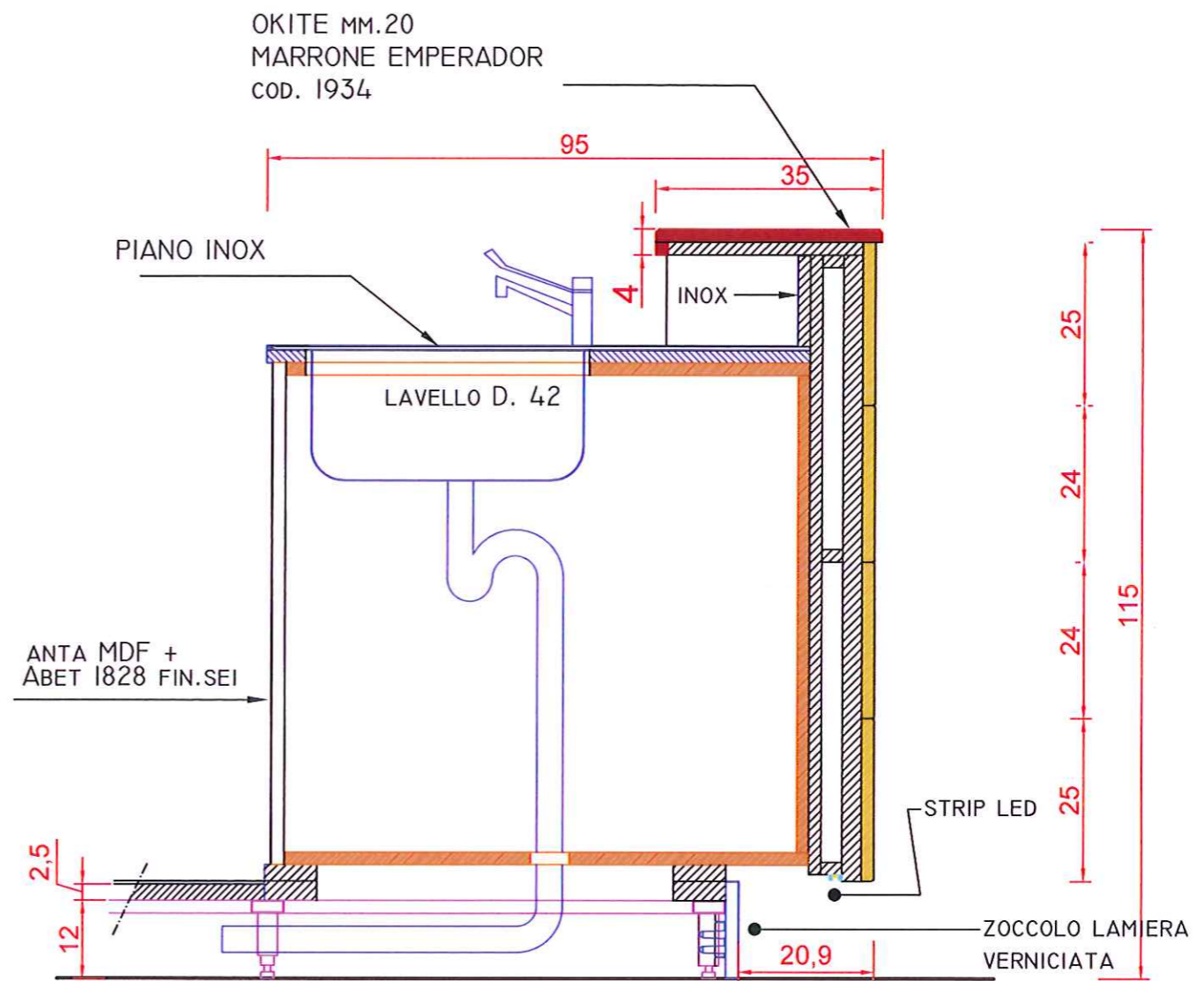

SEZIONE BB': BANCO LAVELLI

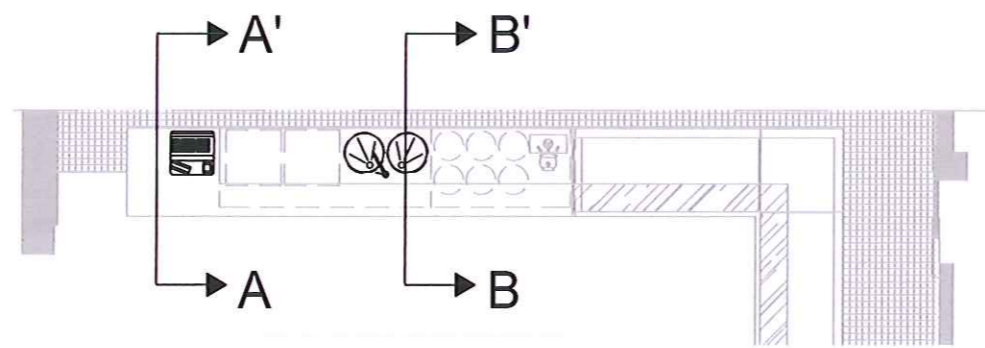

LOCH s.a.s.
Dell'ing. ANDREA LORENZINI & C.
Via 1° Maggio, 24 - 62100 MACERATA
P. N. 06980439

02/09/2015

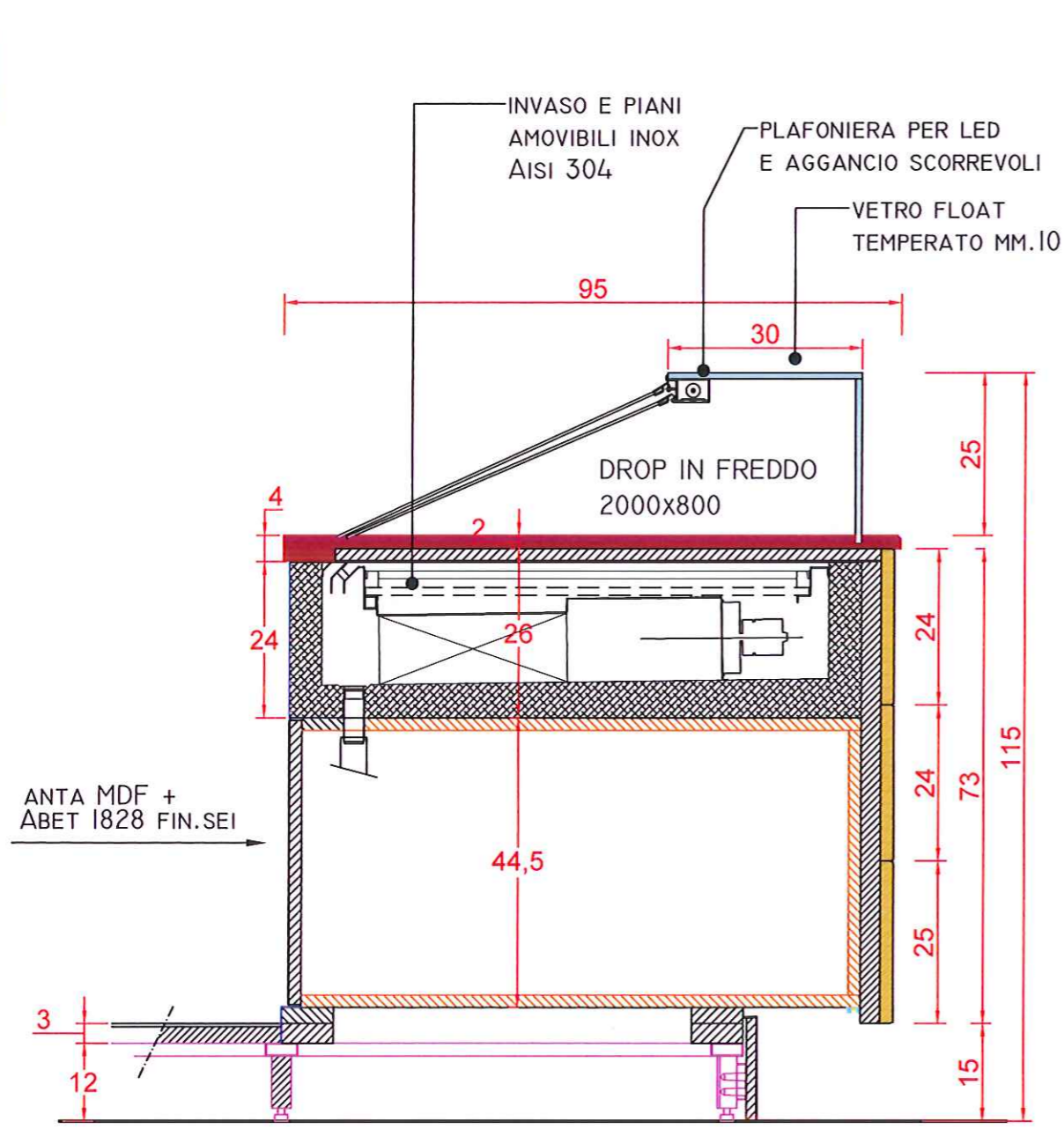

SEZIONE DD': VETRINA FREDDA

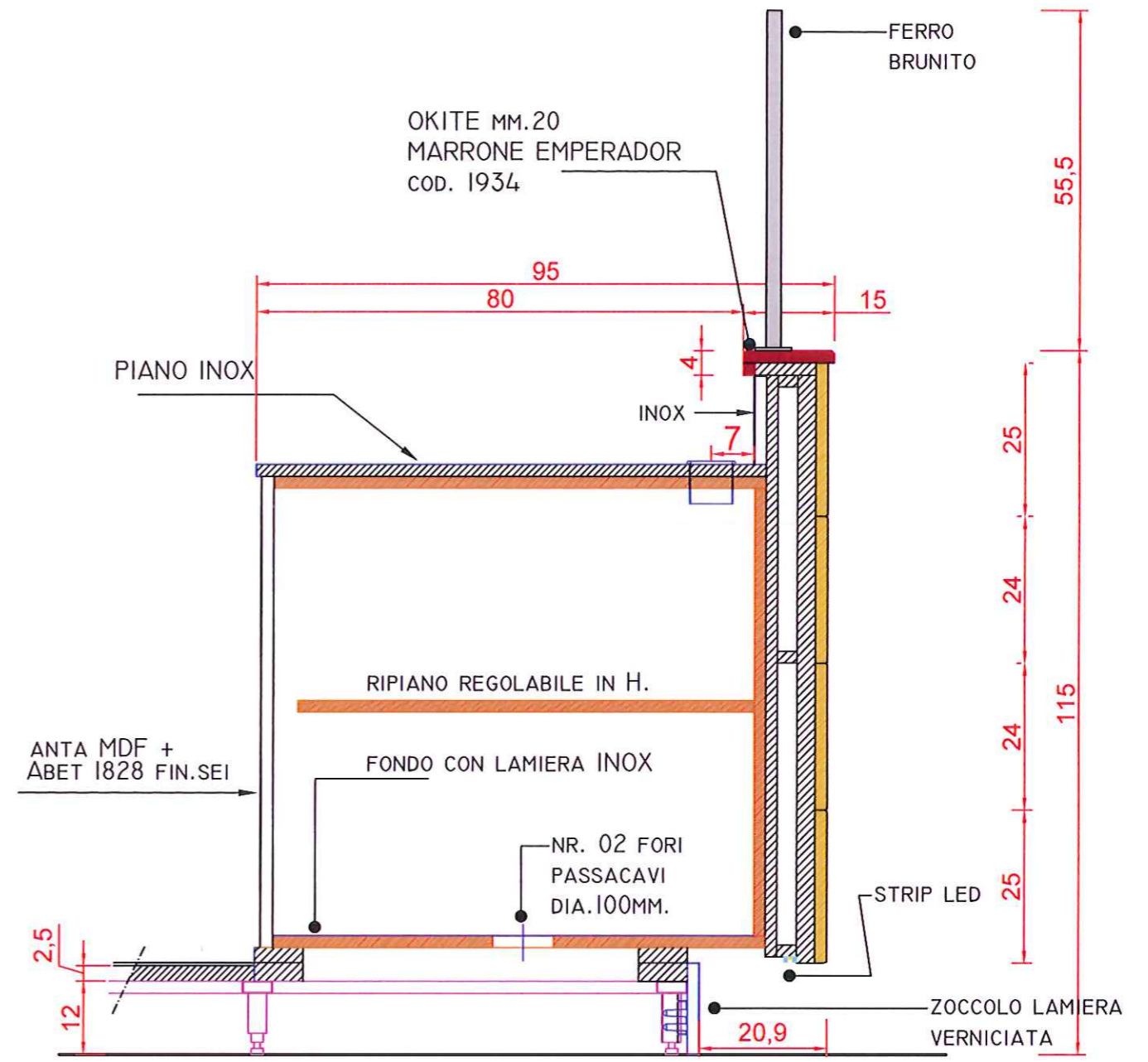

SEZIONE EE': BANCO AFFETTATI

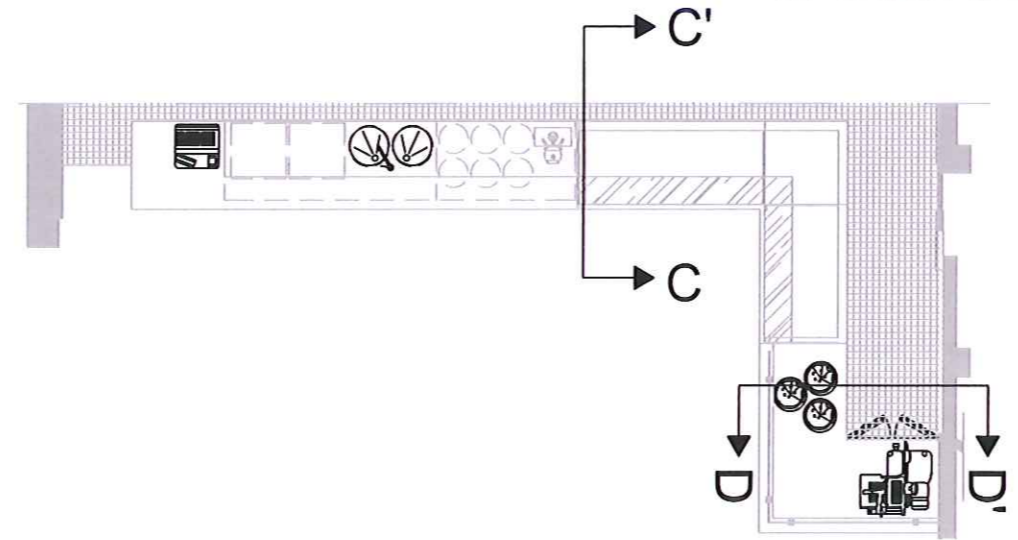



 Loci s.a.s.
 Dell'ing. ANDREA LORENZINI & C.
 V.lel'Industria, 3H - 62100 MACERATA
 Tel. 0733/6980439

PARTICOLARE PEDANA SCALA 1:1
 UNITÀ DI MISURA 1 = 1 MM.

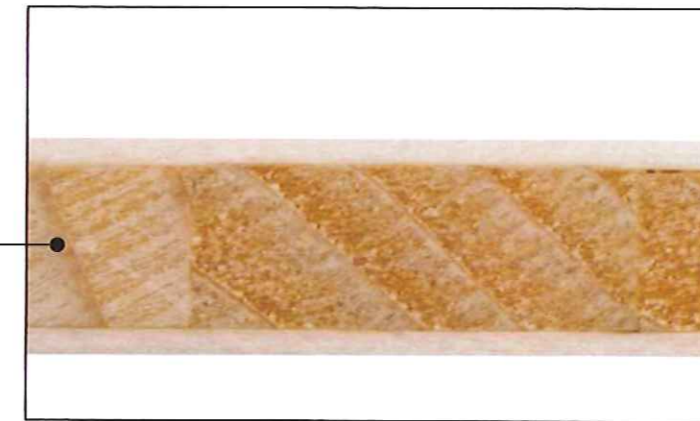
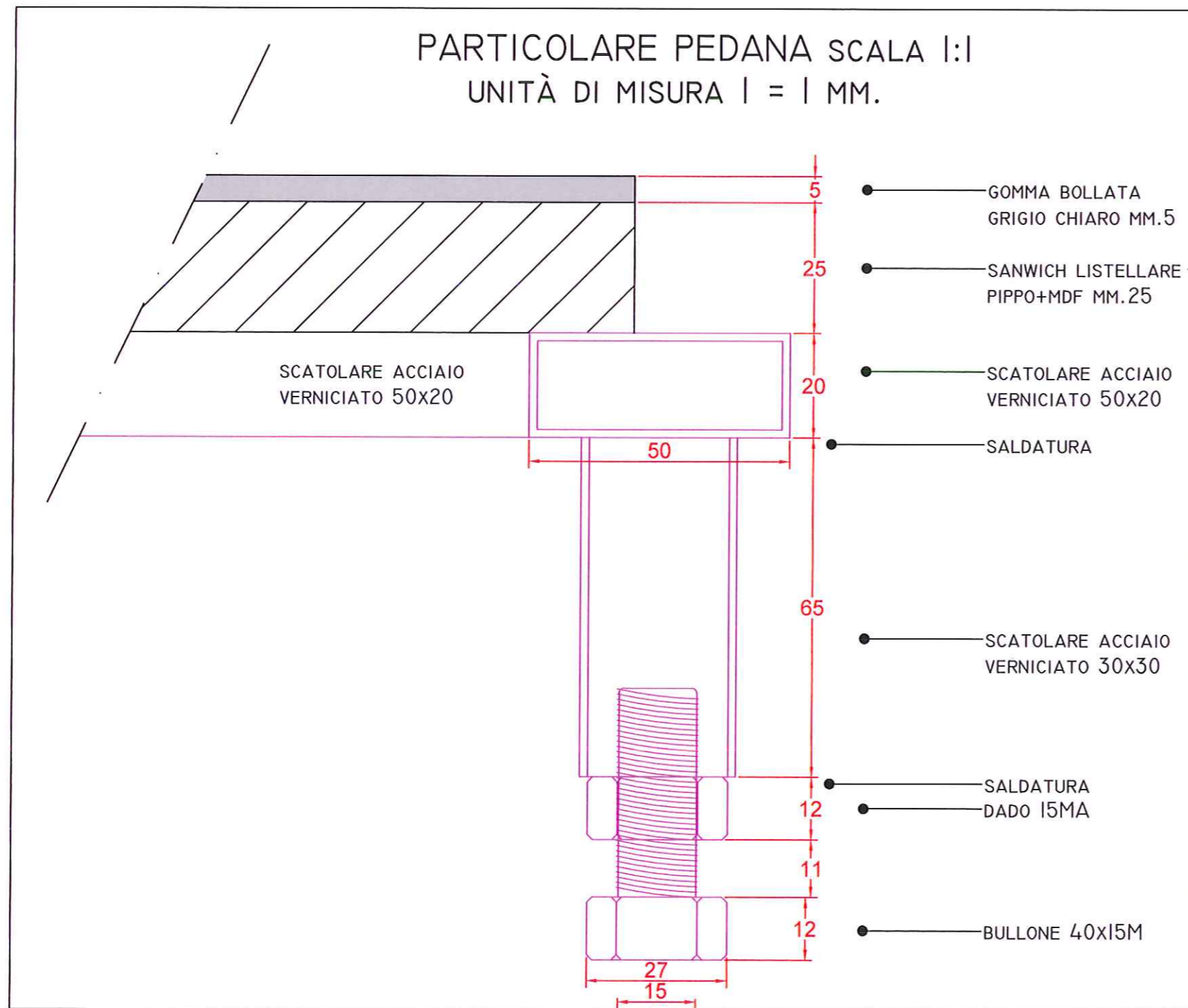

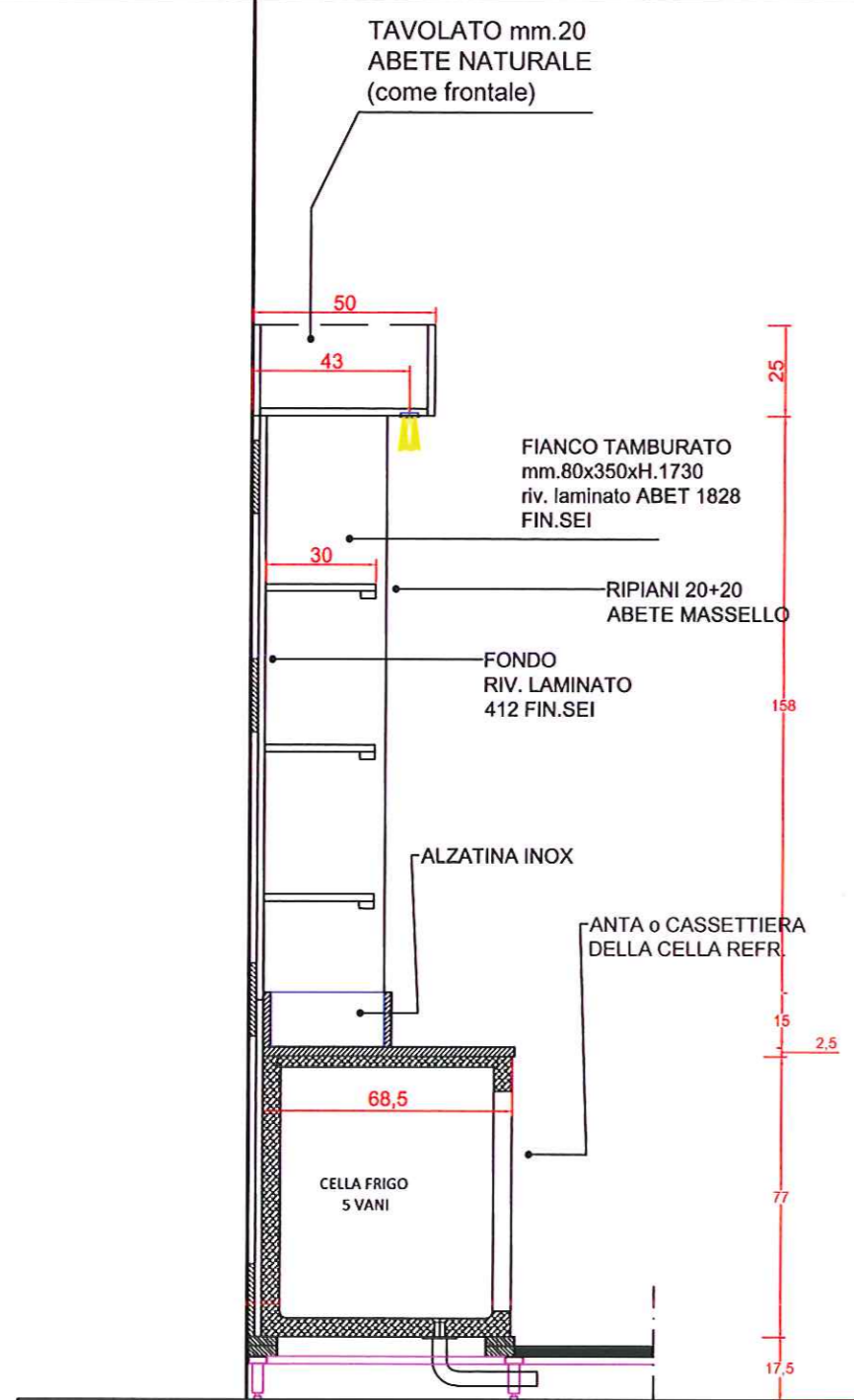

SEZIONE EE': RETRO CELLA REFR.

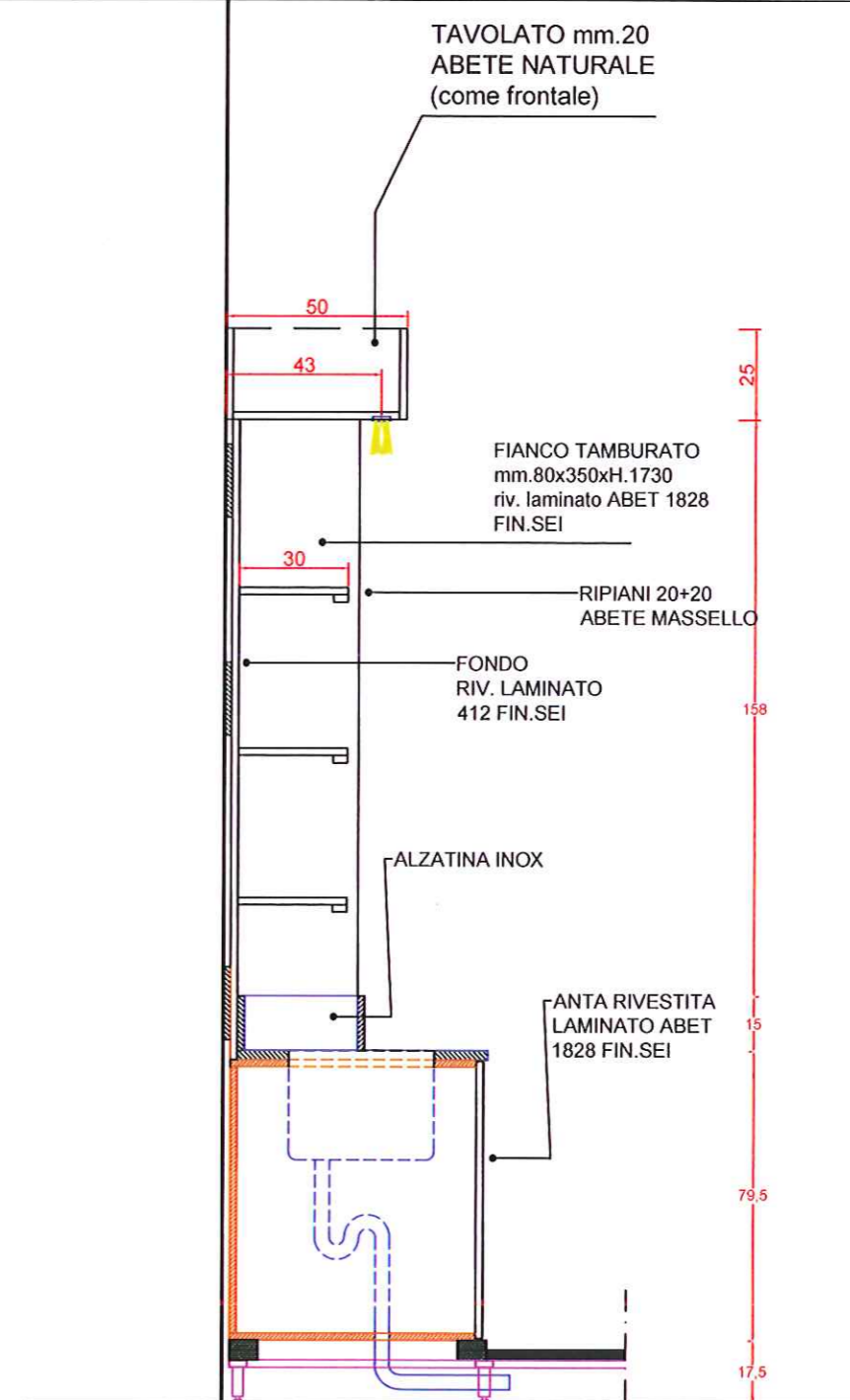

SEZIONE FF': RETRO LAVELLO

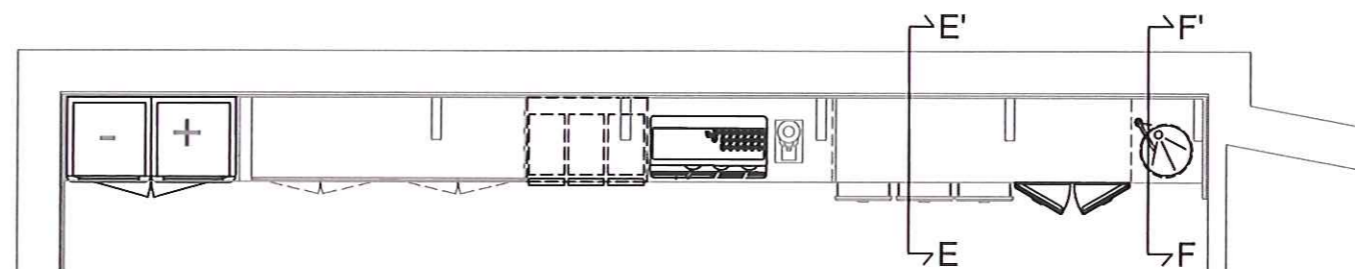

LOCA s.a.s.
 Dell'ing. ANDREA LORENZINI & C.
 Via 1° Maggio, 34 - 62100 MACERATA
 P. IVA 0606980439

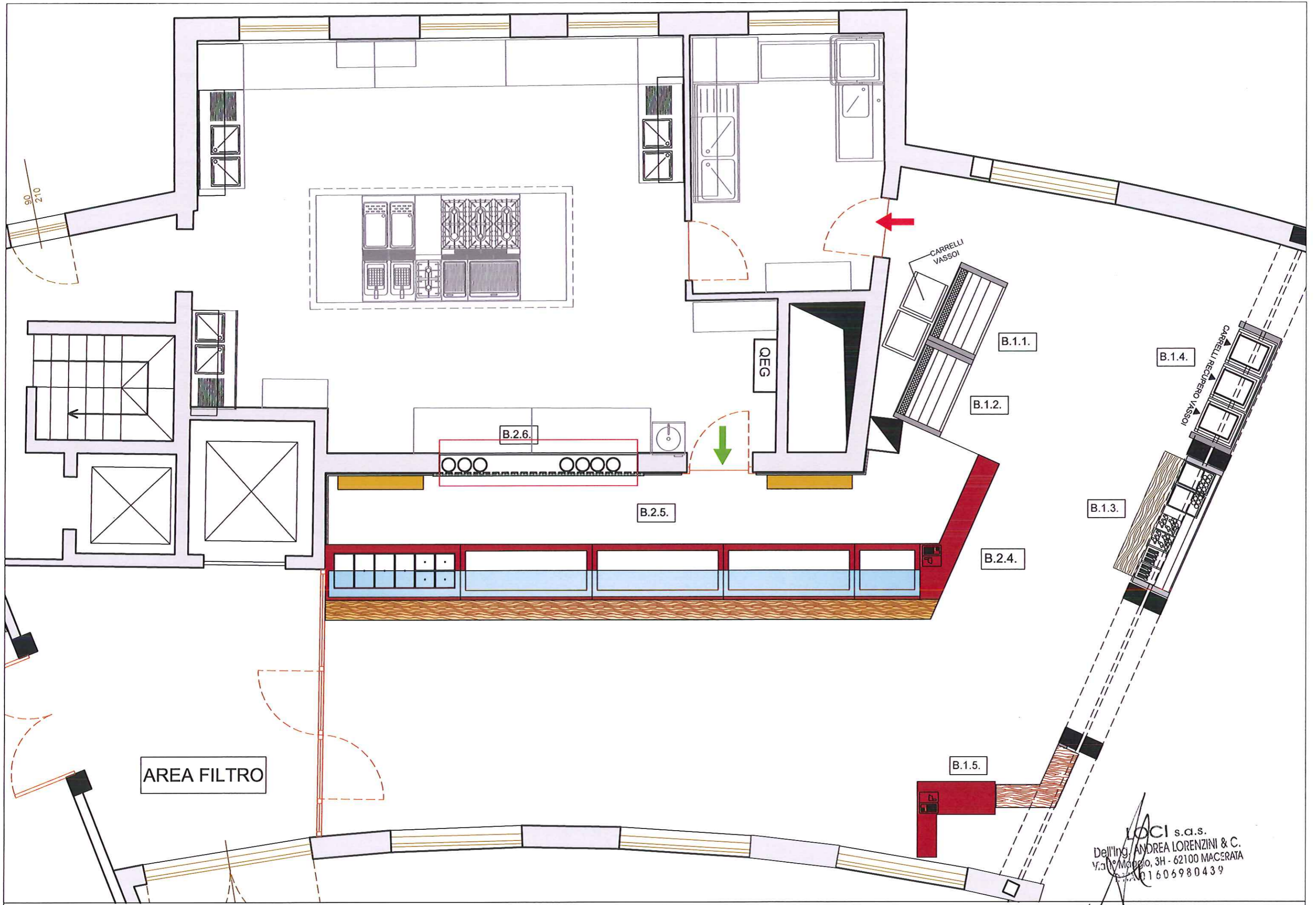

LOCI s.a.s.
 Dell'ing. ANDREA LORENZINI & C.
 Via Maggio, 3H - 62100 MACERATA
 Tel. 0733 606980439

TAV. 03-01 SELF SERVICE PLANIMETRIA TOTALE 04/09/2015 scala 1:50

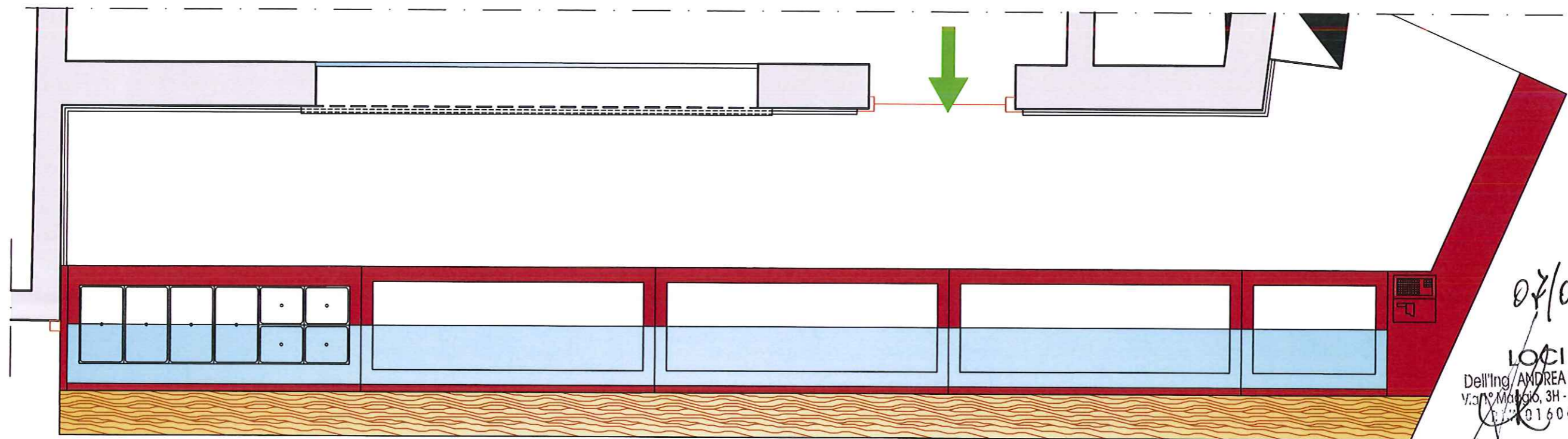
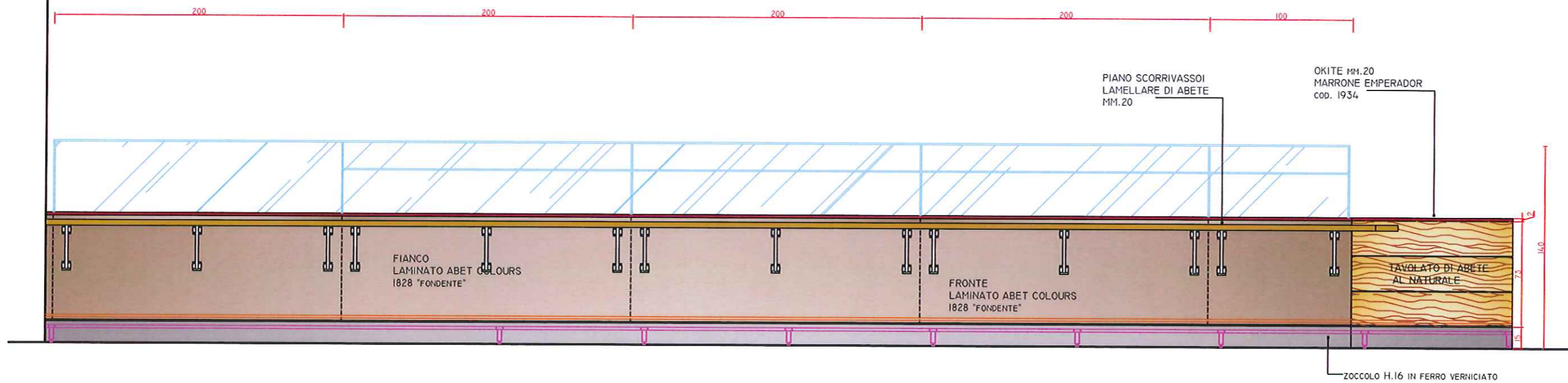

TAV. 03-02

PROSPETTO BANCO SELF SERVICE

SCALA 1:30

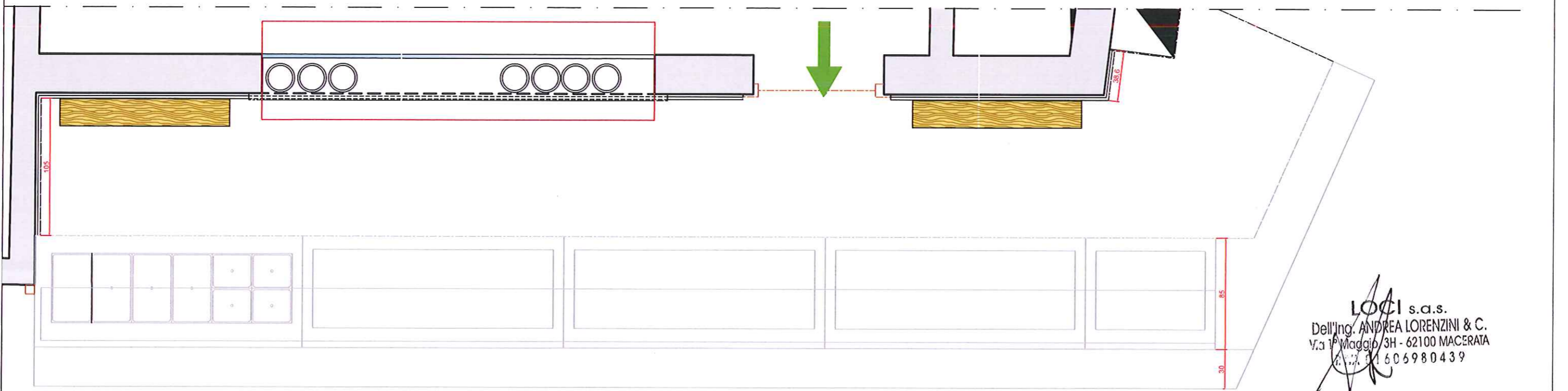
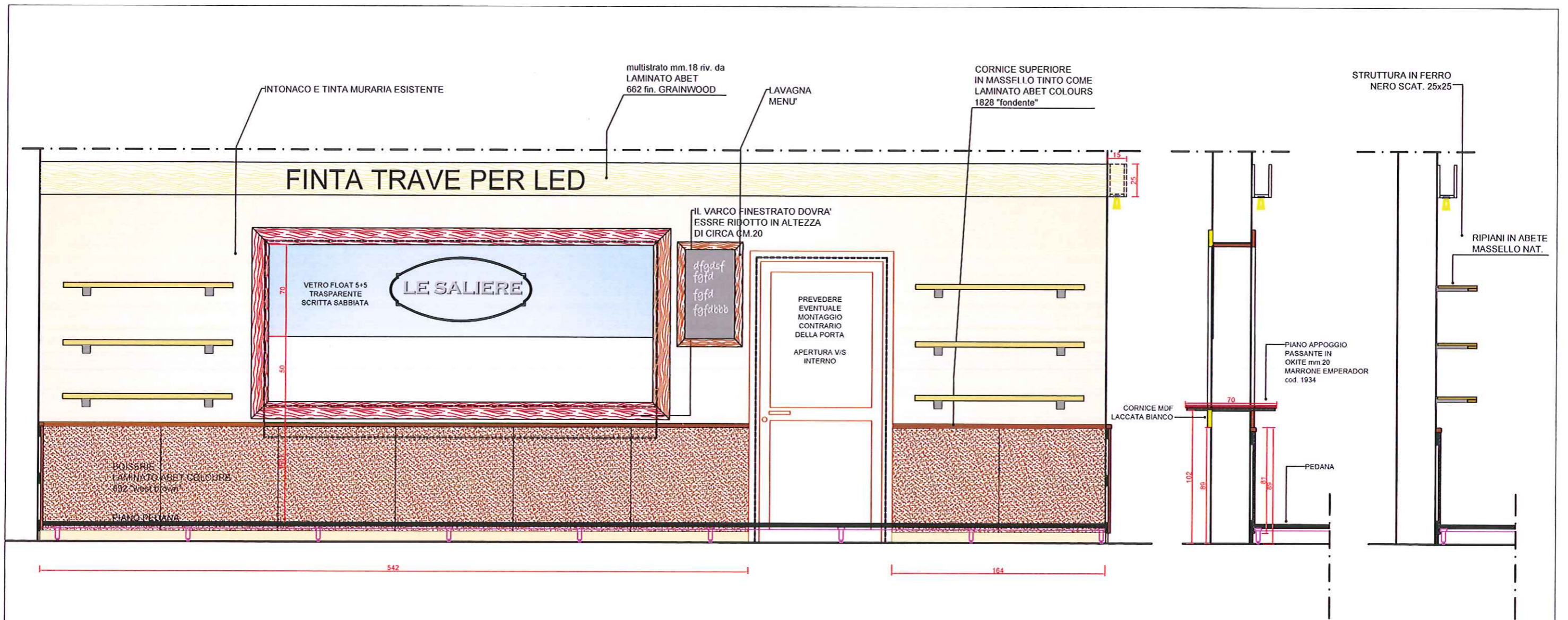

LOCI s.a.s.
 Dell'ing. ANDREA LORENZINI & C.
 V.3 Maggio/3H - 62100 MACERATA
 P.01606980439

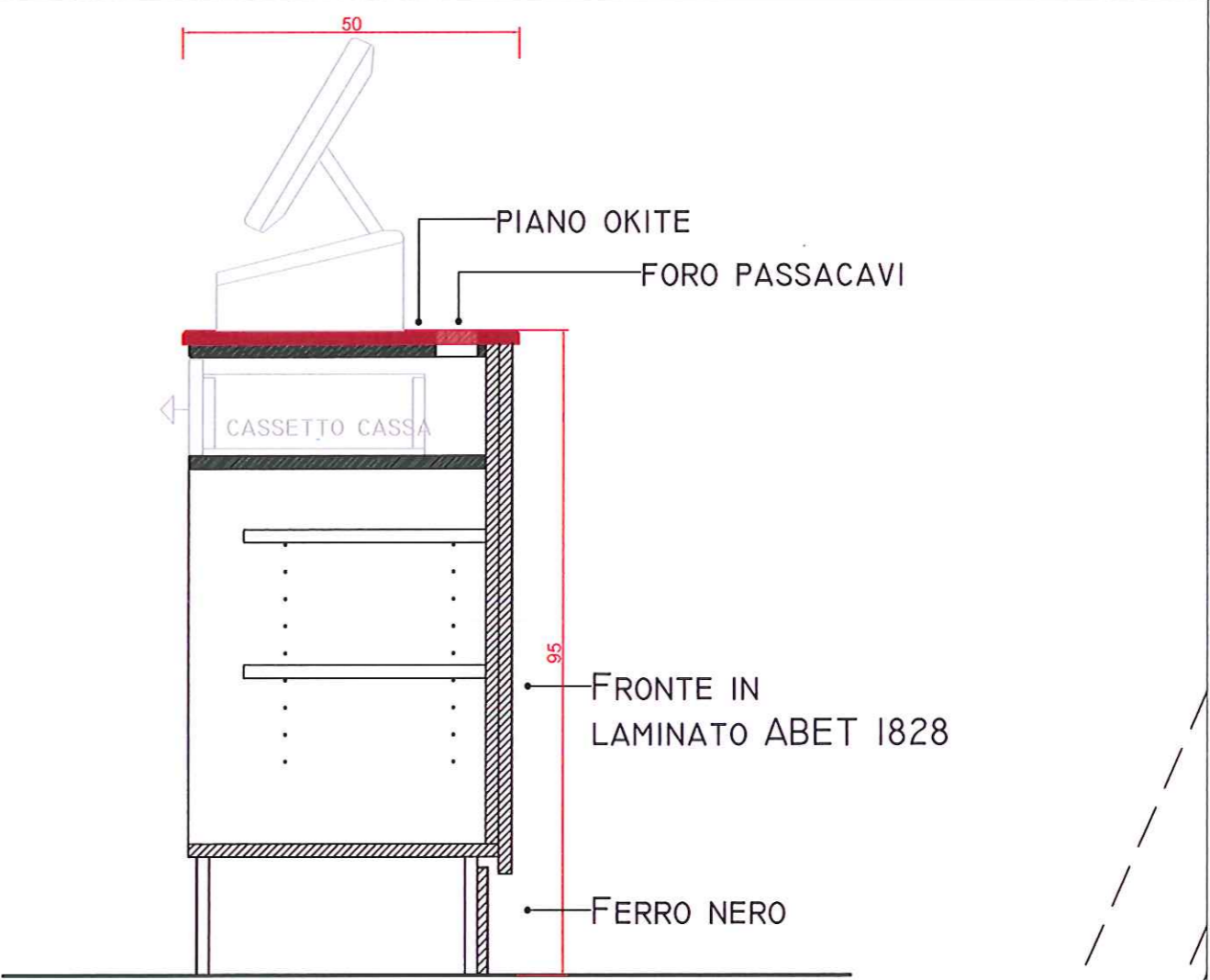
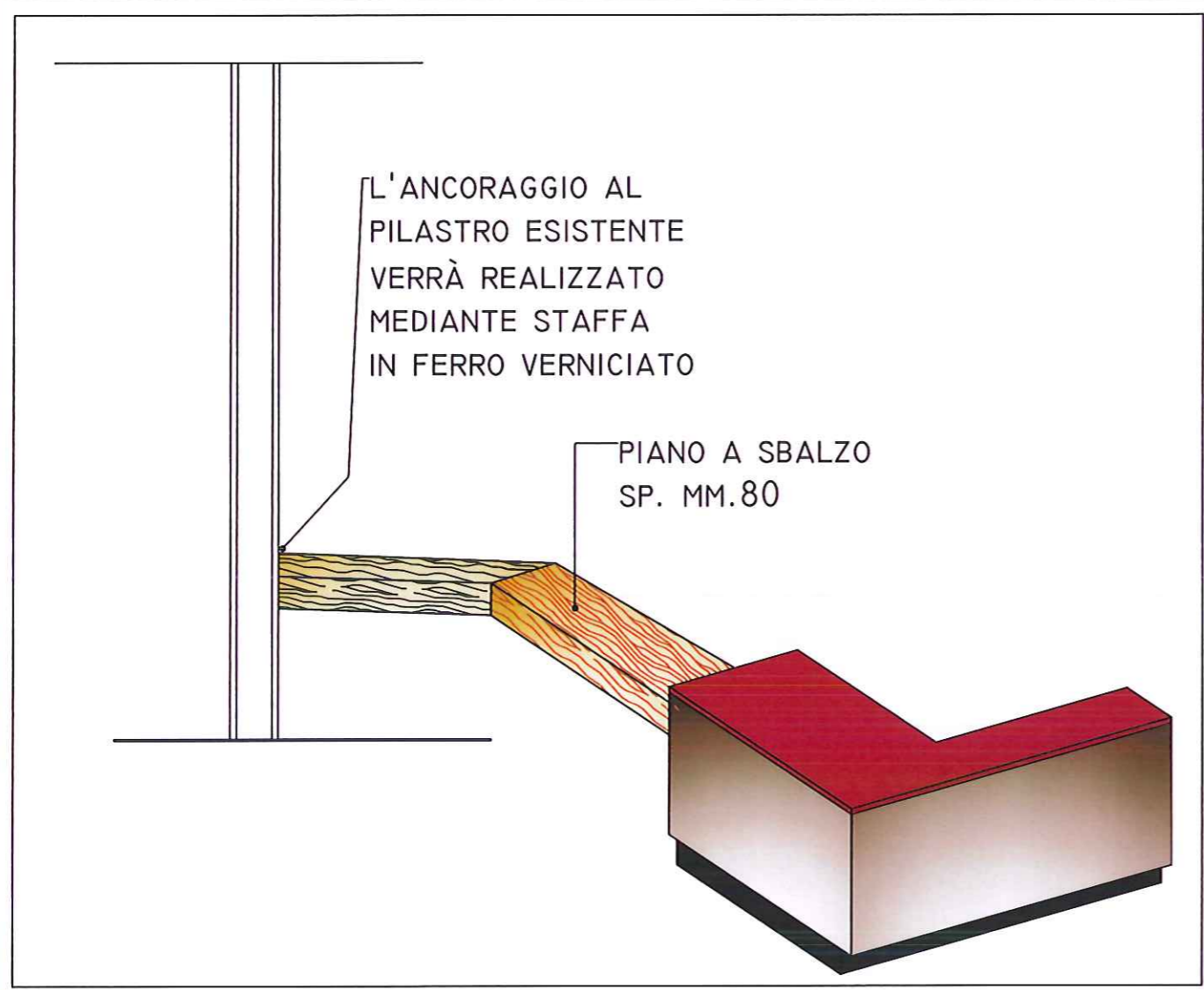

particolare sezione 1:10

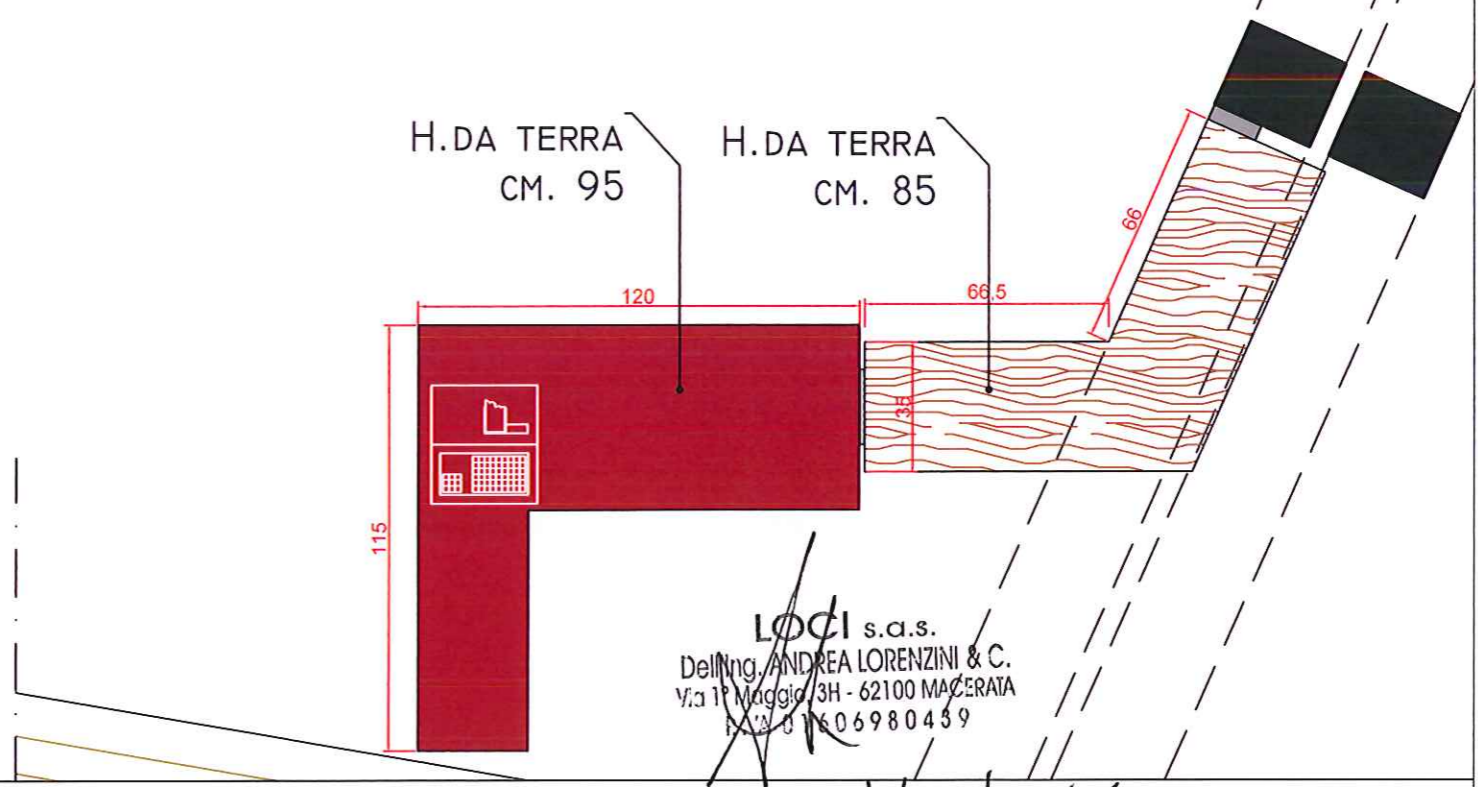



OKITE mm.20
MARRONE EMPERADOR
cod. 1934

PIANO SCORRIVASSOI
LAMELLARE DI ABETE
MM.20

FONDO
LAMINATO ABET COLOURS
892 "west brown"

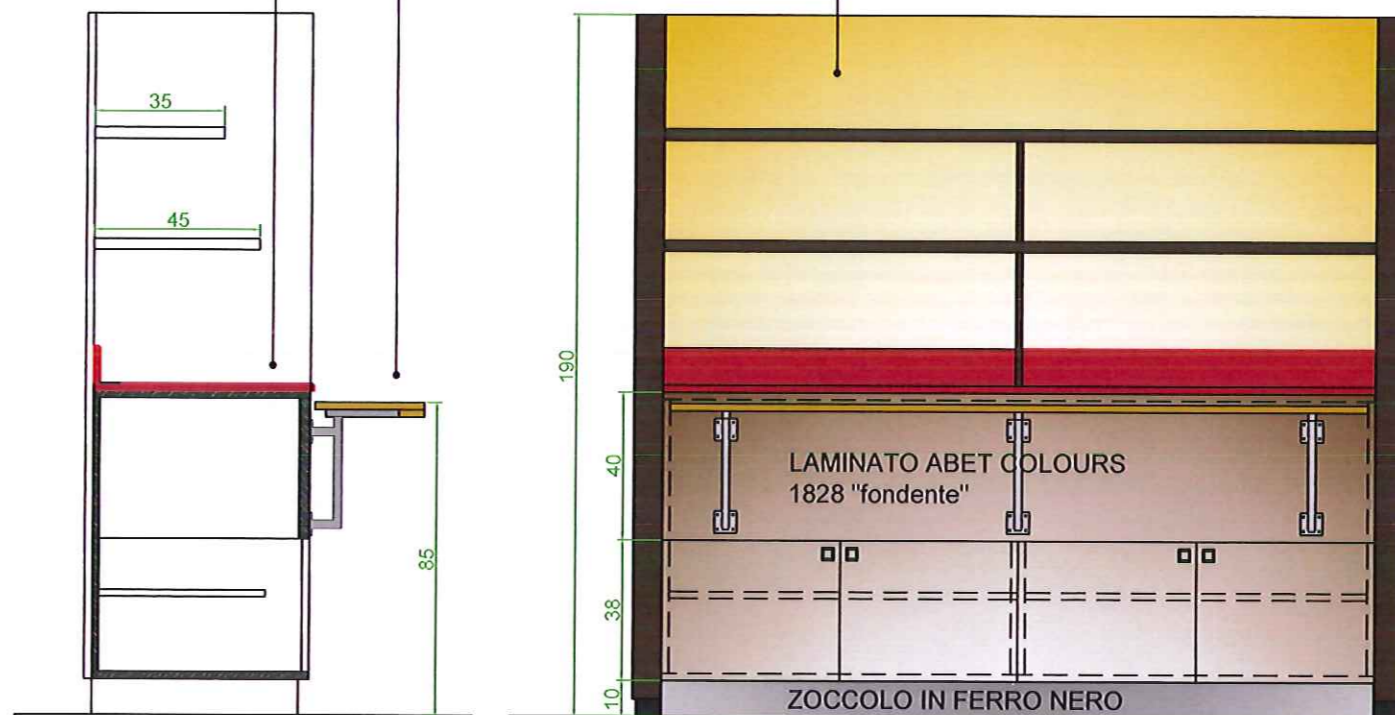

SEZ. AA'

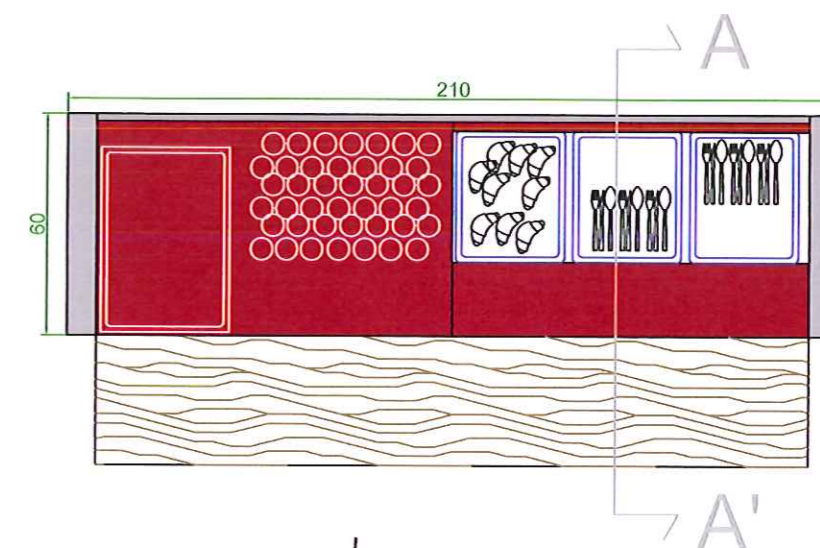
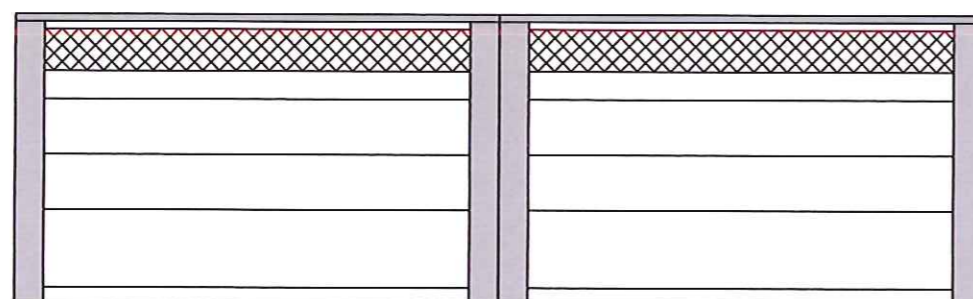

FRIGORIFERI LIBERO SERVIZIO

MOBILE POSATE

LOCI s.a.s.
Dell'ing. ANDREA LORENZINI & C.
Via 1° Maggio, 54 - 62100 MACERATA
P. IVA 01606980439

04/09/2019

TAV. 03-05

SELF SERVICE

ELEMENTI LIBERO SERVIZIO

scala 1:20

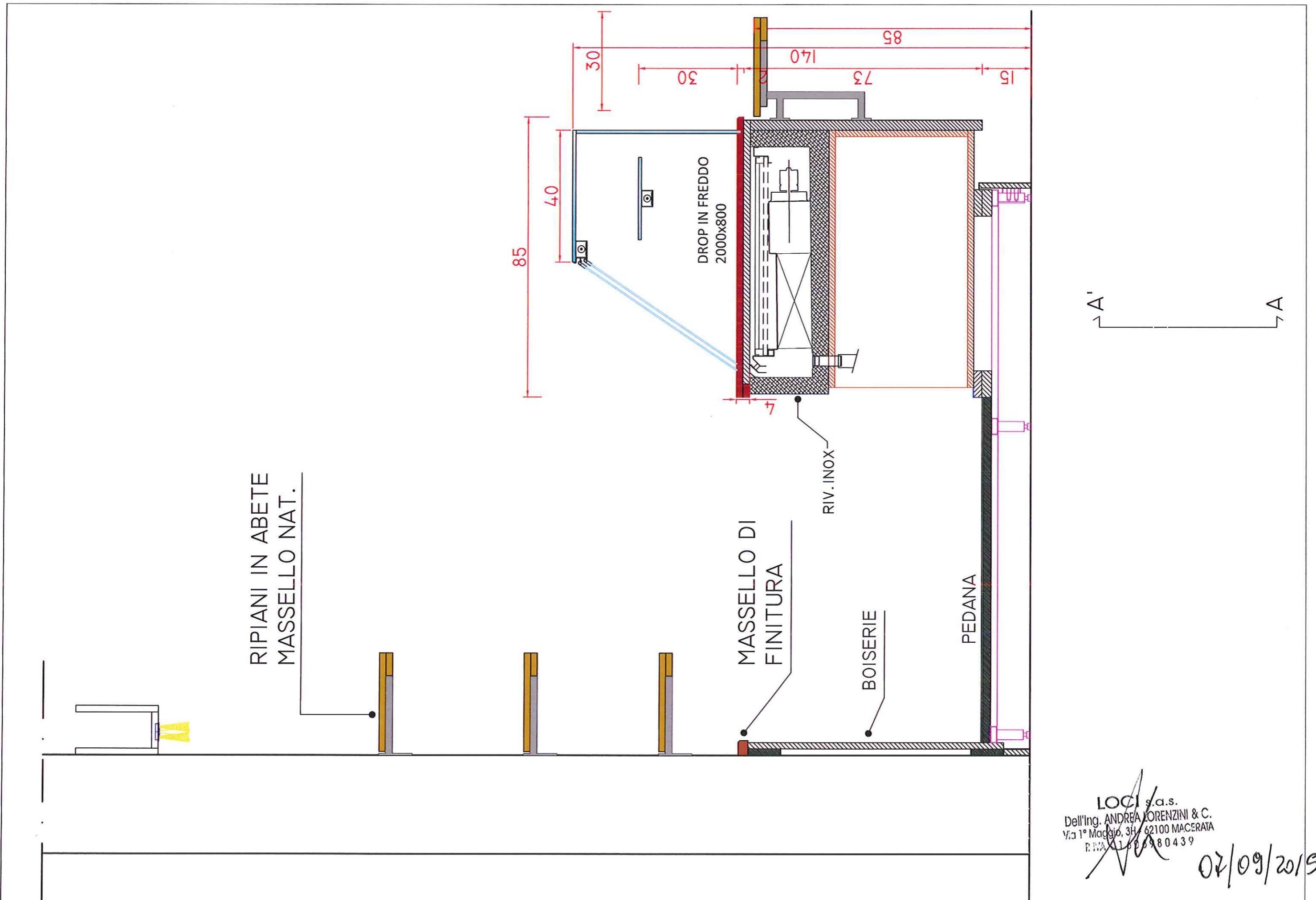

RIPIANI IN ABETE
MASSELLO NAT.

MASSELLO DI
FINITURA

BOISERIE

PEDANA

DROP IN FREDDO
2000x800

RIV. INOX

TAV. 03-06

SELF SERVICE

SEZIONE AA'

SCALA 1:10

LOCI s.d.s.
 Dell'ing. ANDREA LORENZINI & C.
 Via 1° Maggio, 3H - 62100 MACERATA
 P.IVA 01600980439
 02/09/2015

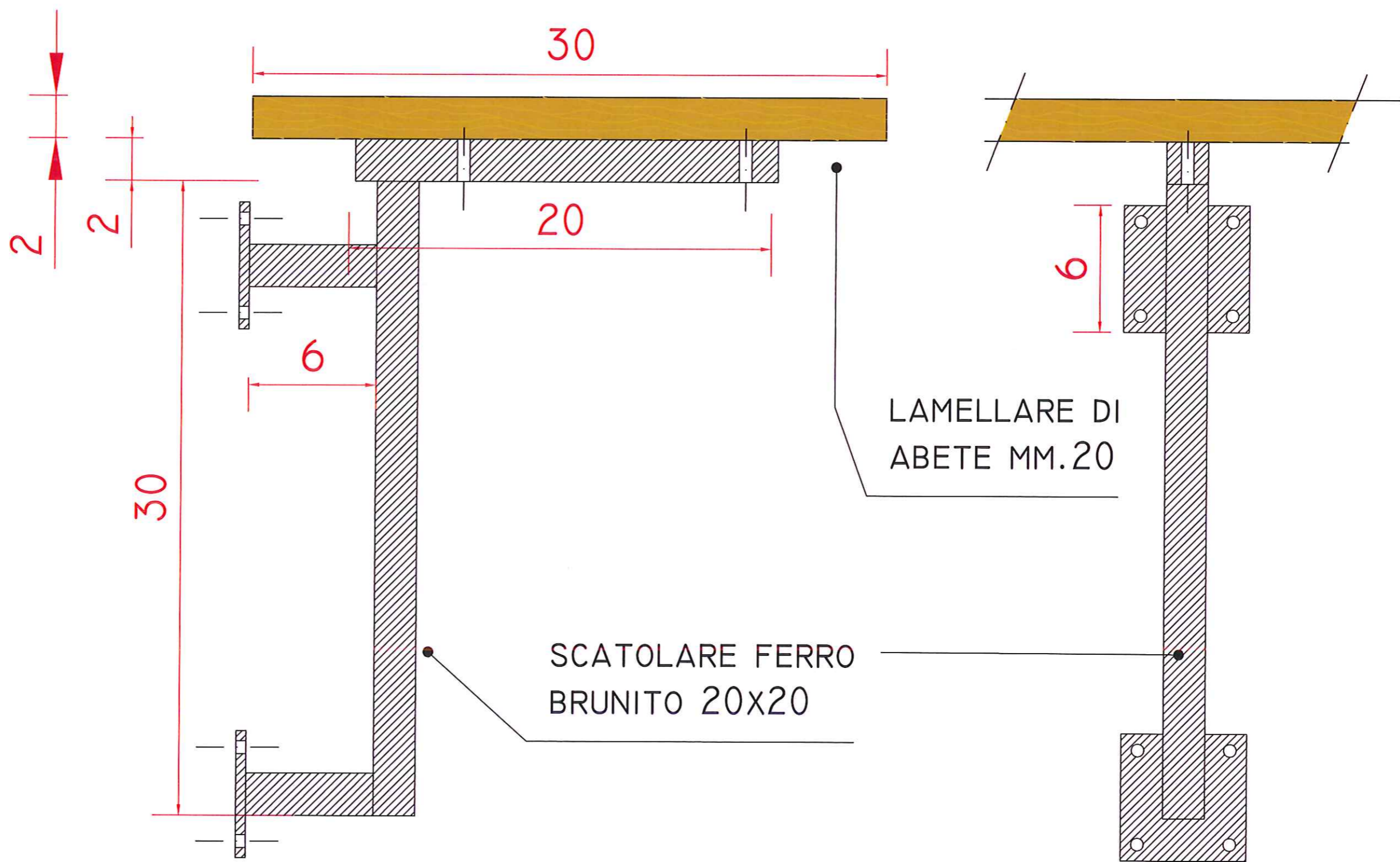

LAMELLARE DI
ABETE MM.20

SCATOLARE FERRO
BRUNITO 20x20

LOC s.a.s.
Dell'ing. ANDREA LORENZINI & C.
V. 1° Maggio, 8H 62100 MACERATA
P. IVA 01606980439

07/09/2015

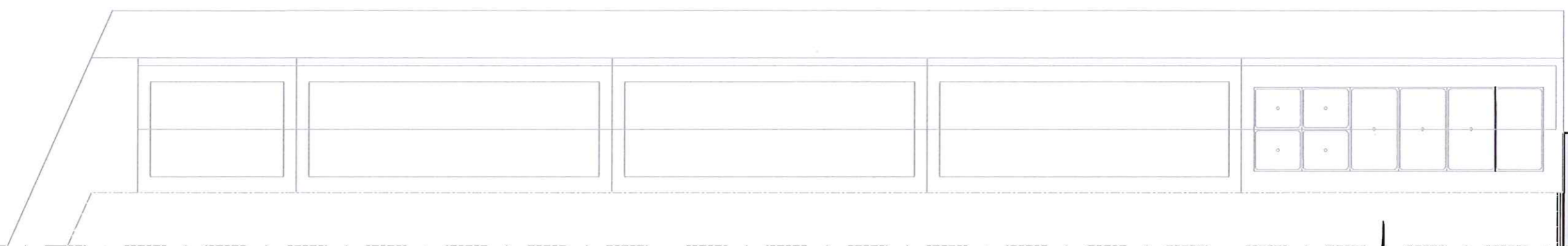
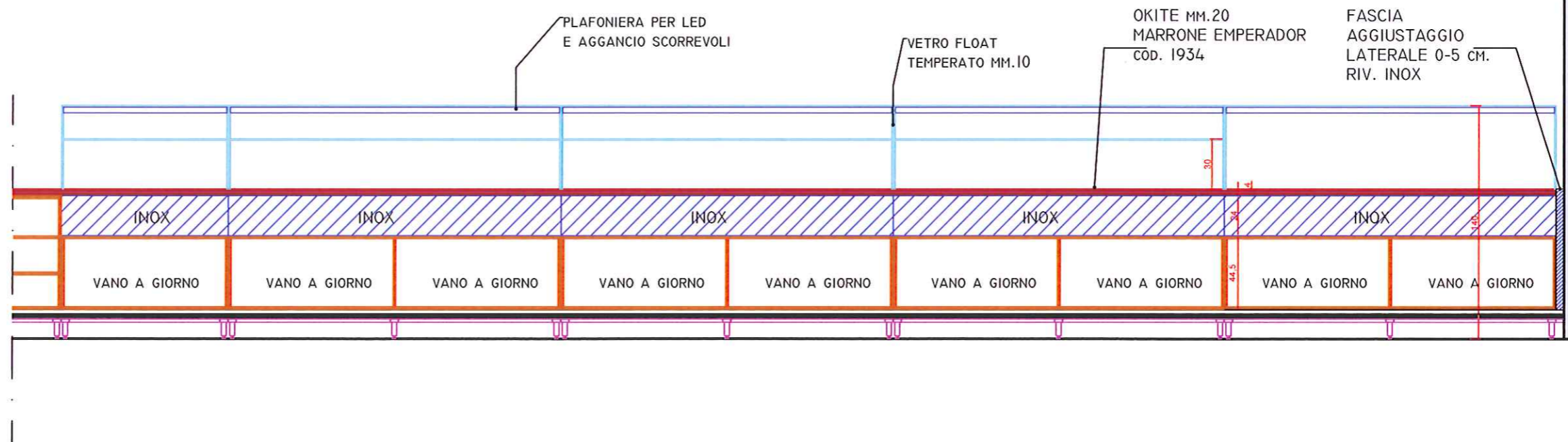

LOCI s.a.s.
 Dell'ing. ANDREA LORENZINI & C.
 Via 1° Maggio 3H - 62100 MACERATA
 P. 0733 2160698043

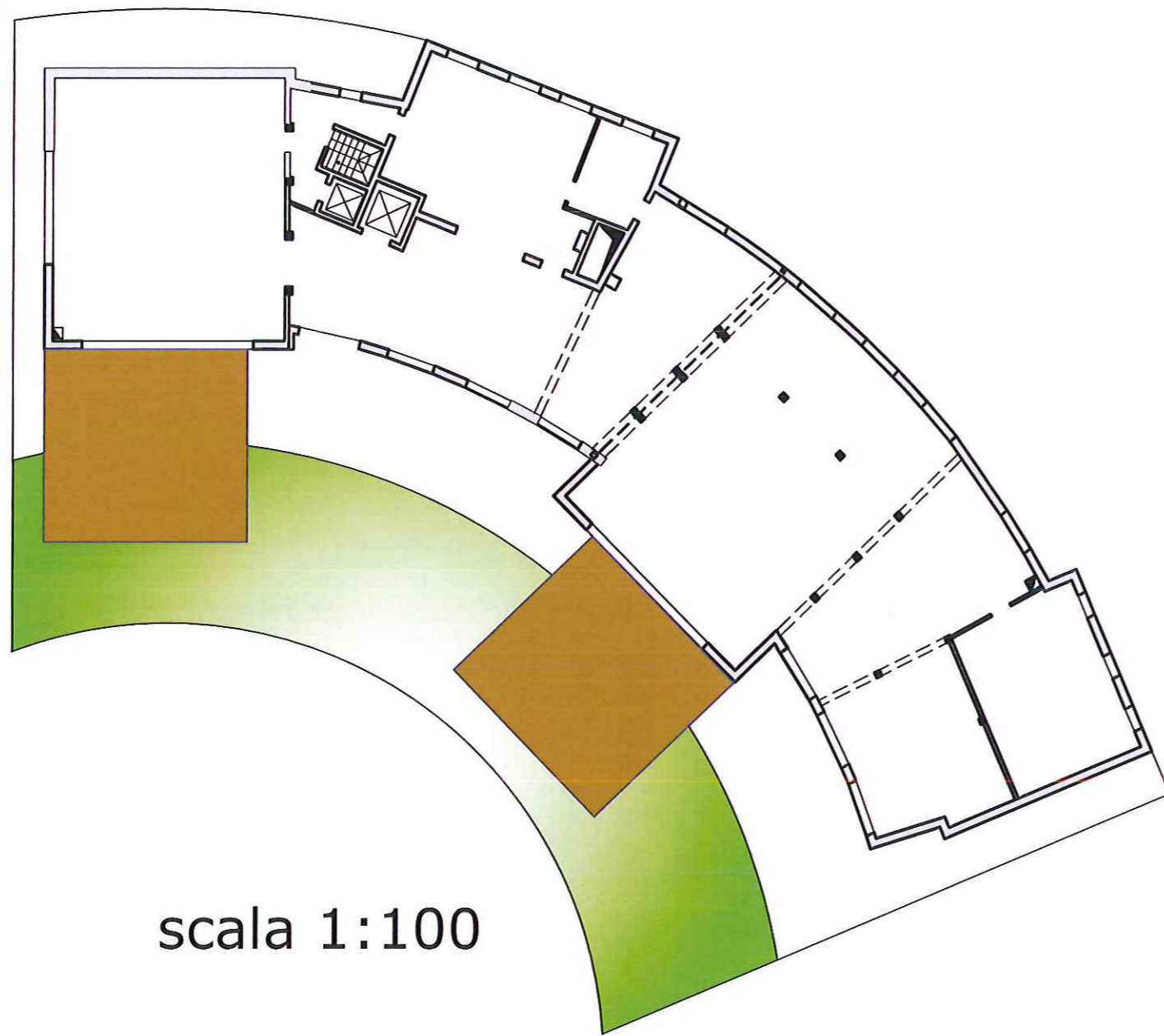

scala 1:100

TAV. 04-01



TERRENO CON PENDENZA DEL 0,5%

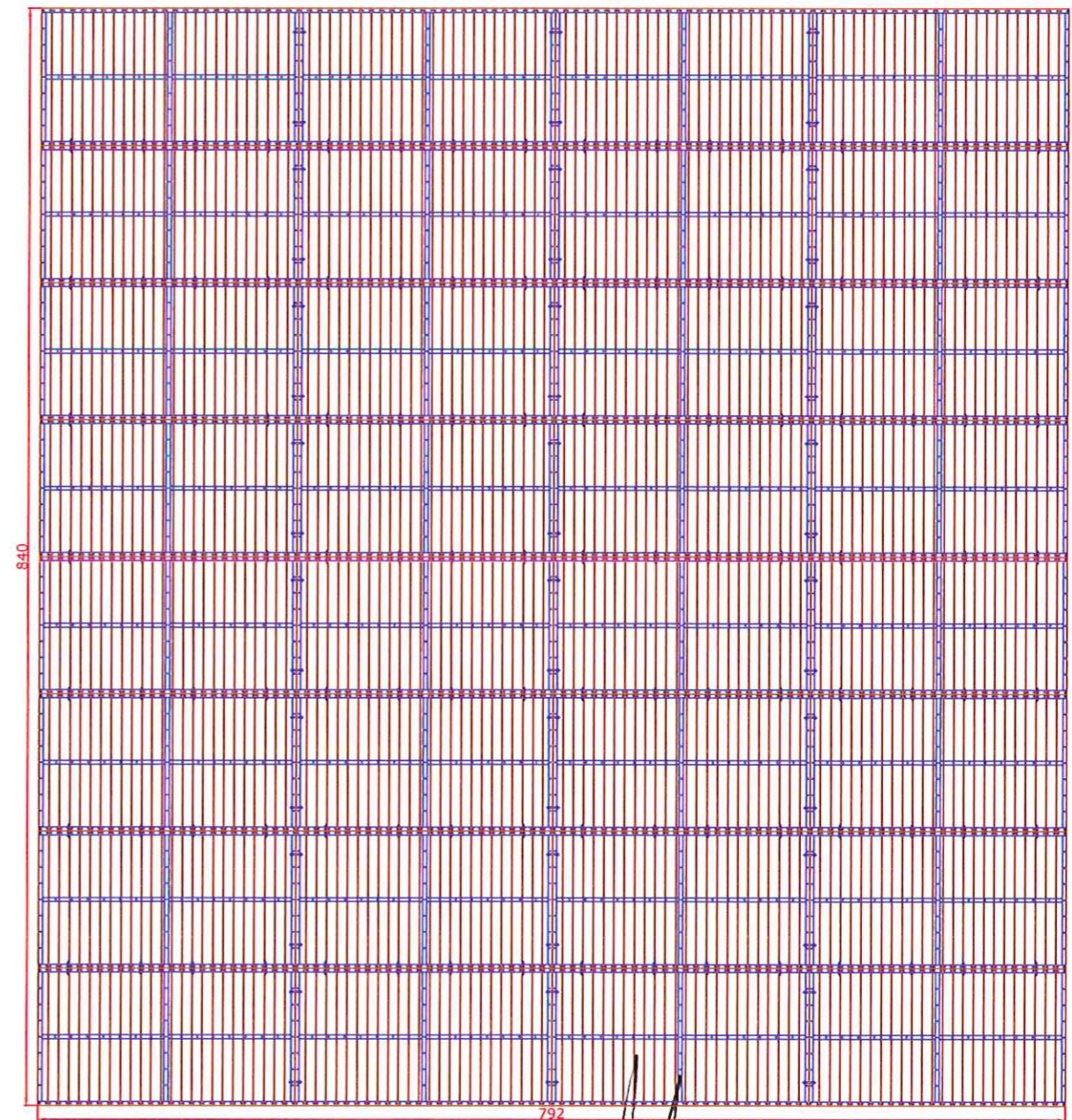

PEDANA ESTERNA

LOC s.a.s.
 Dell'ing. ANDREA LORENZINI & C.
 Via 1° Maggio, 2/A - 62100 MACERATA
 P.IVA 01606980439

07/09/2015

scala 1:50

BULLONERIA
INOX
D'ARREDO

BARRIERA
FRANGIVENTO IN
PERSPEX mm.10

"BICCHIERE" IN
SCATOLARE INOX
1,5 x 550 x 40 x 60

ASTA IN
SCATOLARE INOX
1,5 x 1500 x 50 x 30

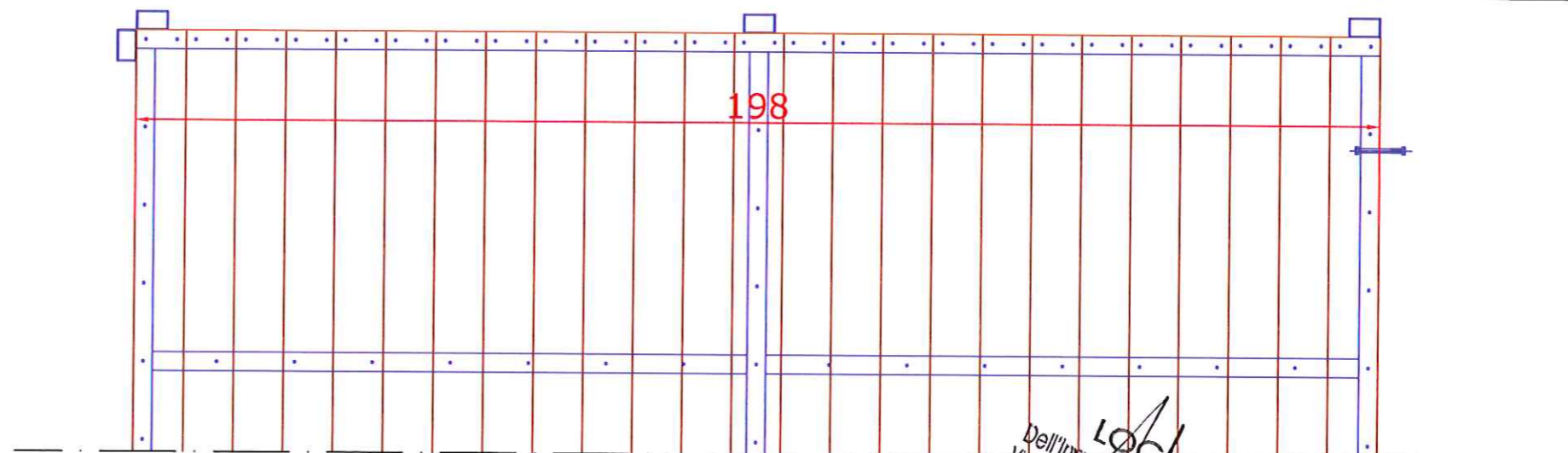
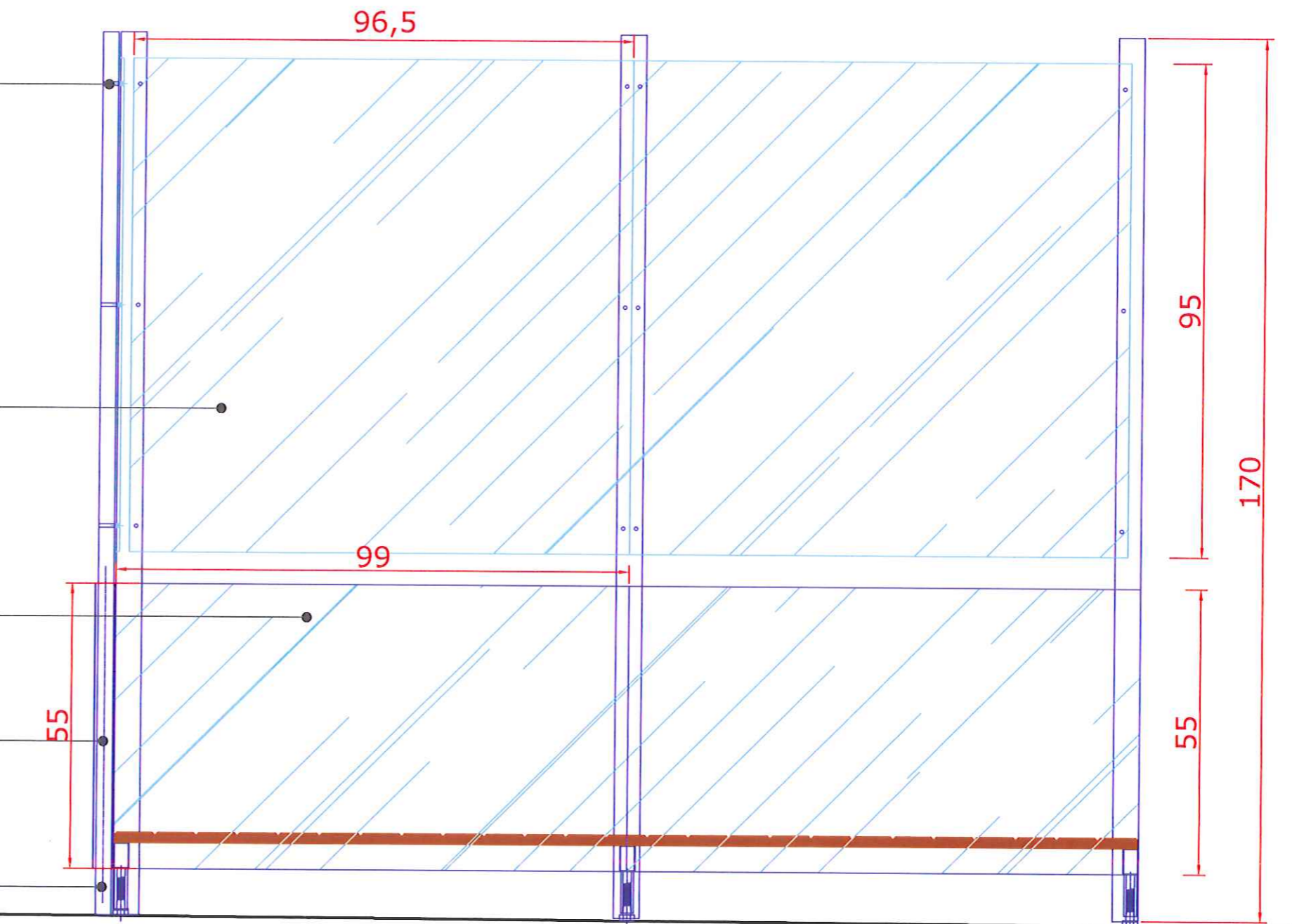
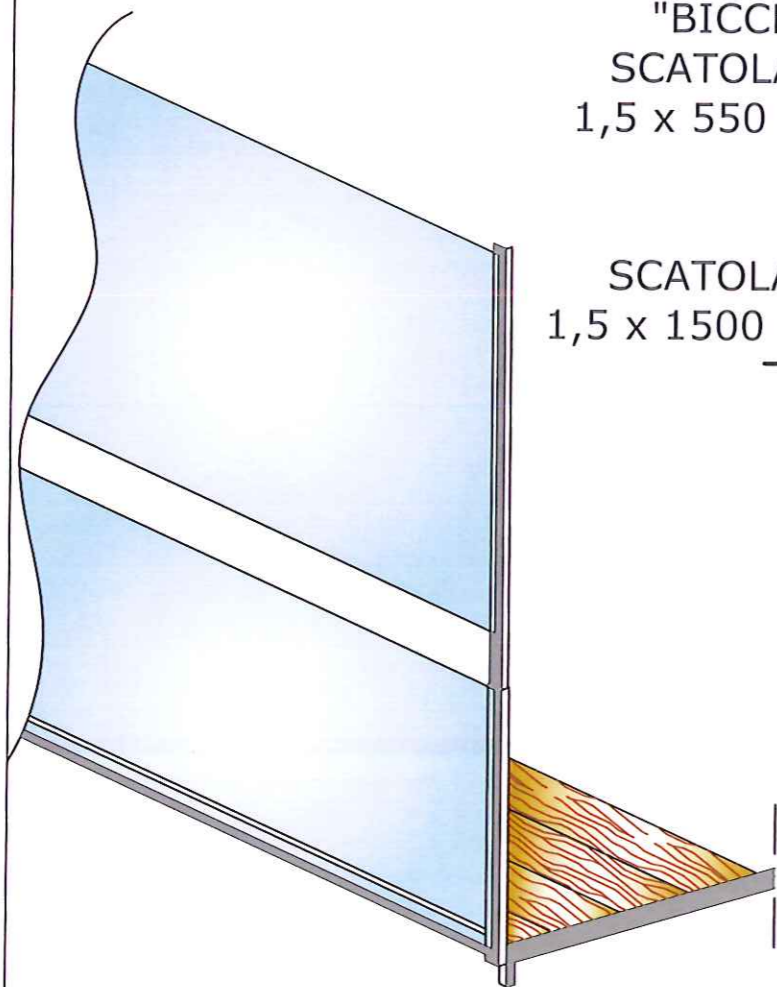

TAV. 04.02 PEDANA ESTERNA PARTICOLARI

LOL s.a.s.
Dell'ing. ANDREA LORENZINI & C.
via T. Maggio, 31 - 62100 MACERATA
P. IVA 07806980439
07/09/2015
Scala 1:10

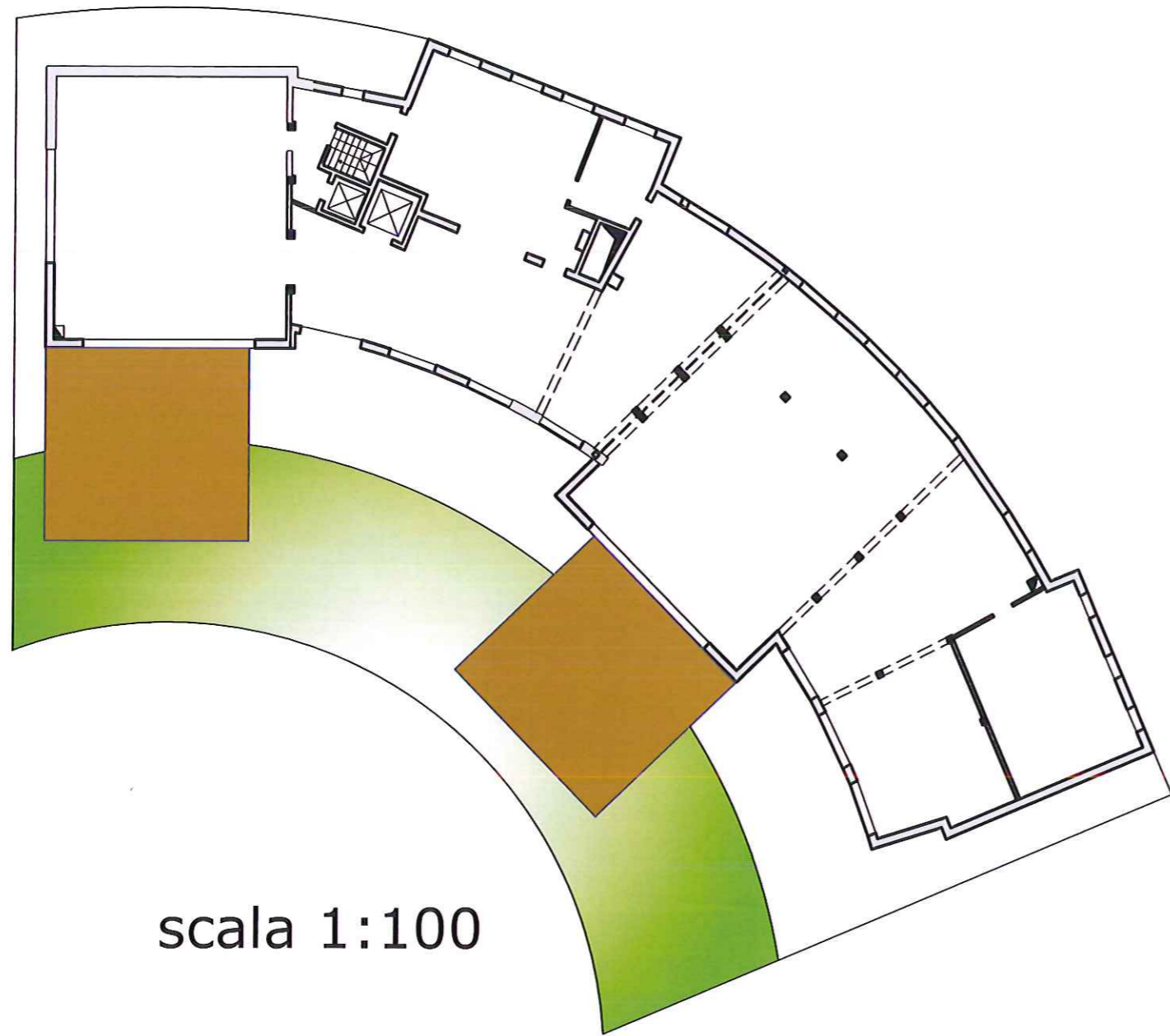

scala 1:100

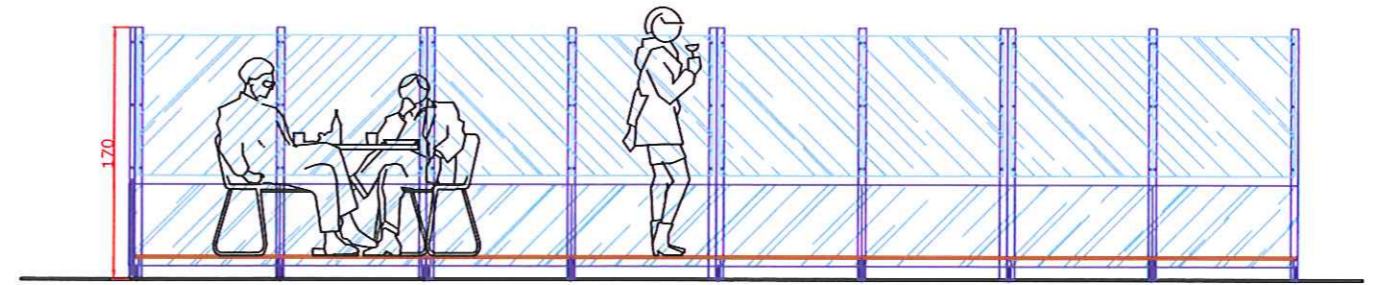

INVERNALE

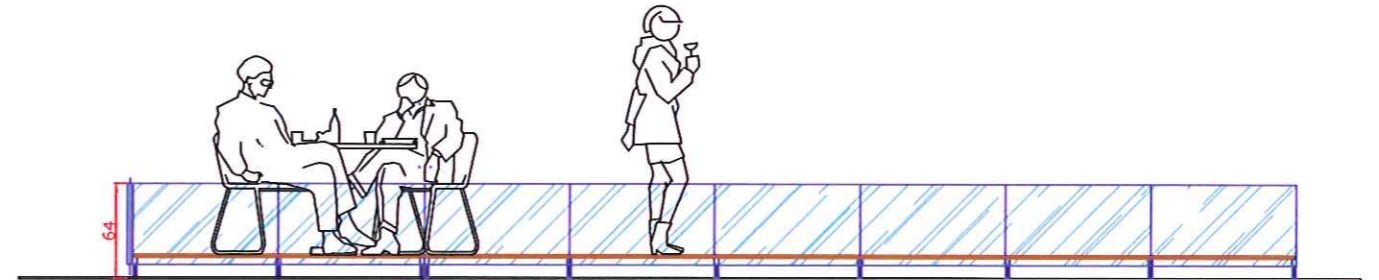

ESTIVO

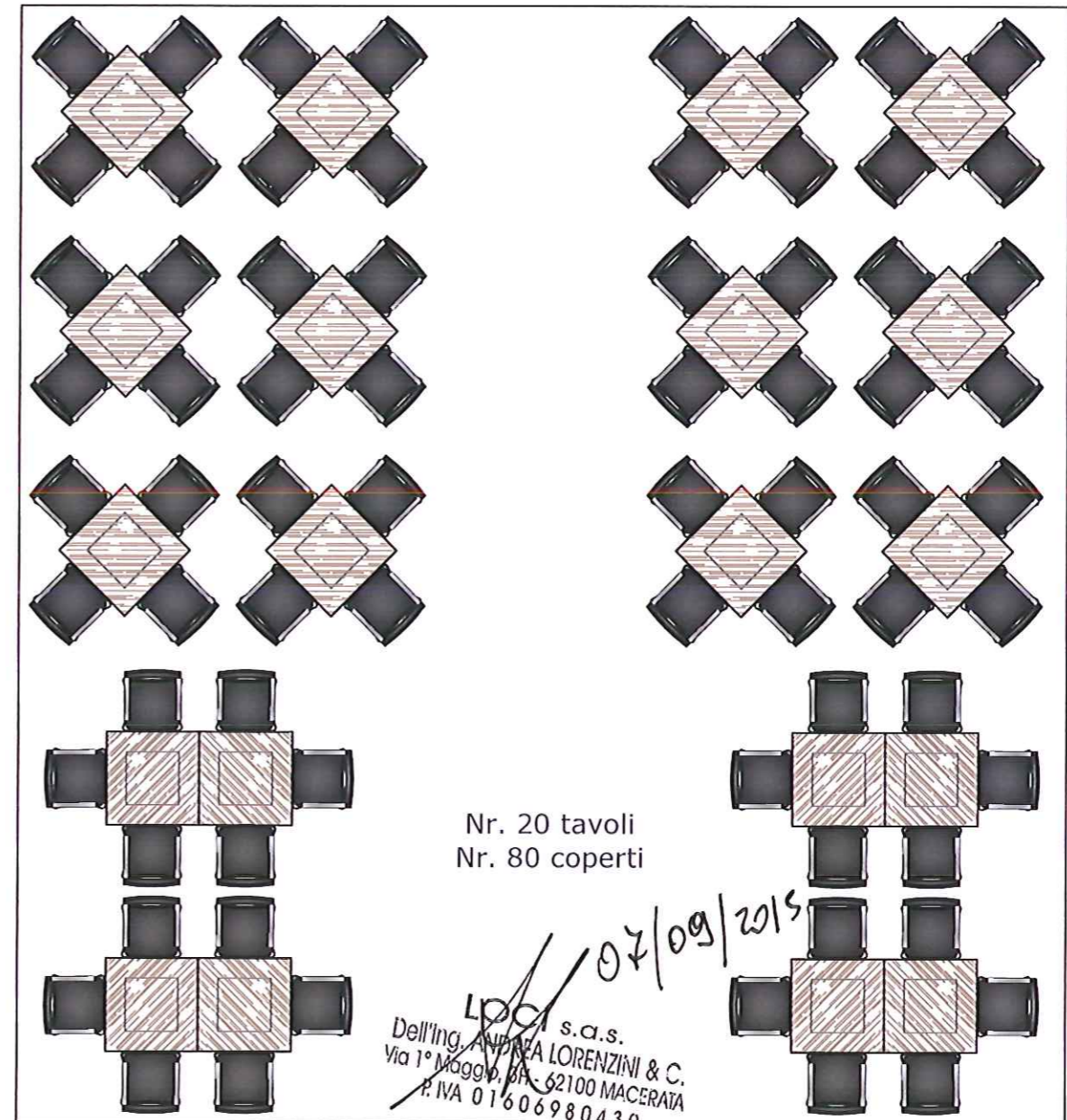

Nr. 20 tavoli
Nr. 80 coperti

07/09/2015
LPC s.a.s.
Dell'ing. ANPA LORENZINI & C.
Via 1° Maggio, 61 - 62100 MACERATA
P. IVA 01606980439

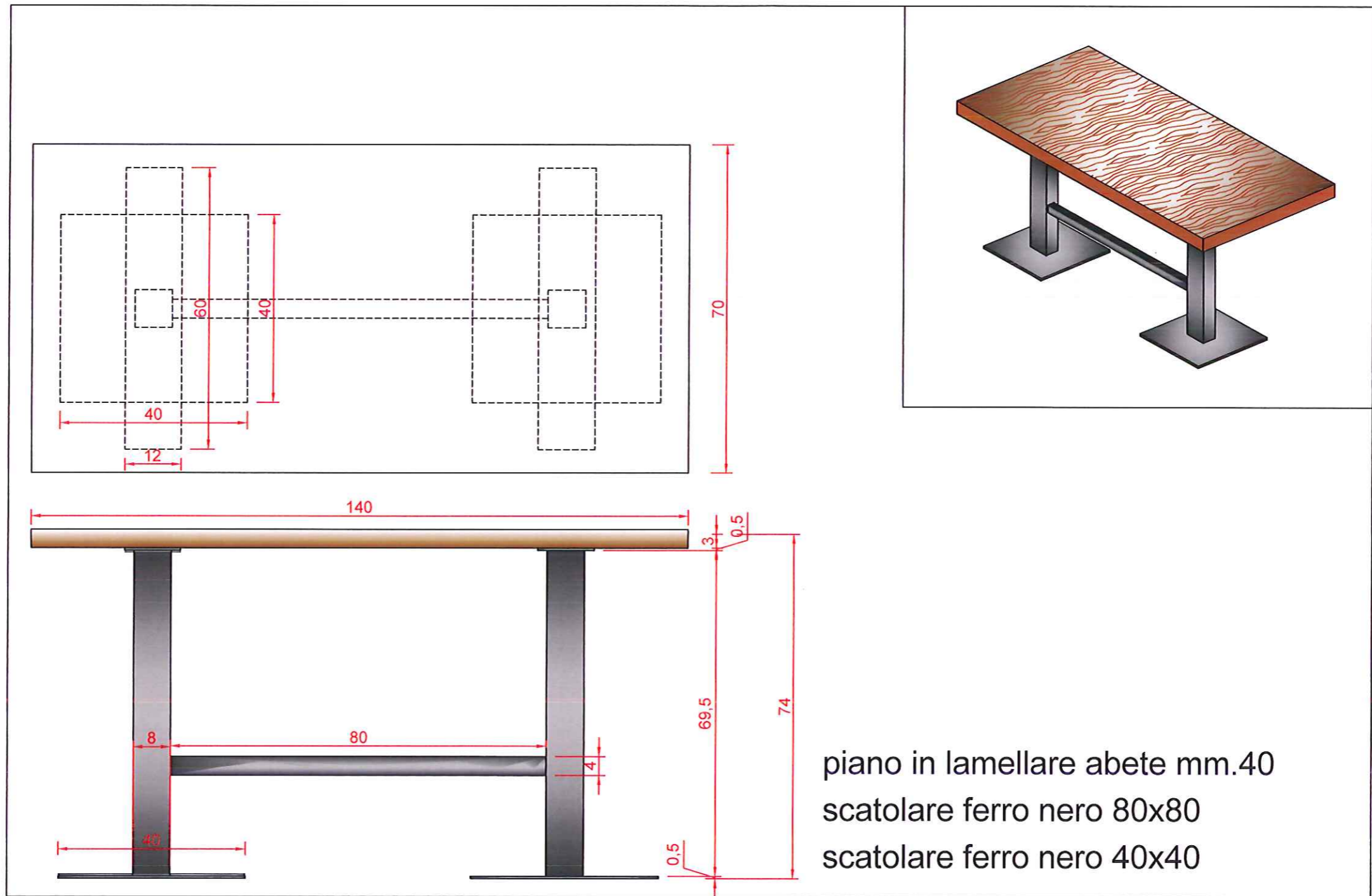

LOO s.a.s.
 Dell'ing. ANDREA LORENZINI & C.
 Via 1° Maggio, 71 - 62100 MACERATA
 P.IVA 01606980439

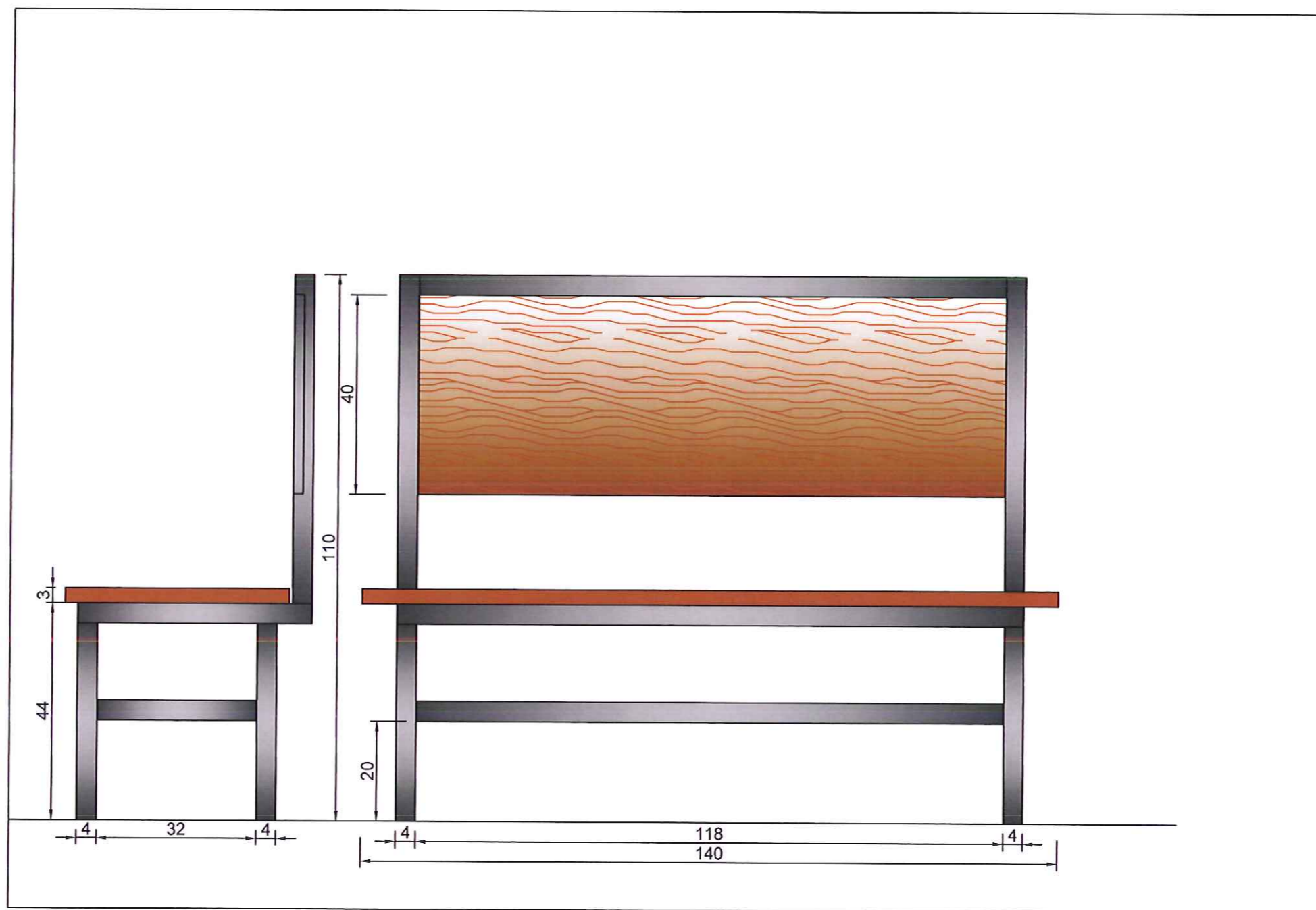

TAV. 05-03 PARTICOLARE PANCA

LOCI s.a.s.
Dell'ing. ANDREA LORENZINI & C.
Via 1° Maggio, 31 - 62100 MACERATA
P. IVA 01606980439

07/09/2015

scala 1:10